



LED 150

Replaces 400 Watt MH Area Light!

RAB | Outdoor

Specification-Grade Optics

ALED 150

RAB engineered "specification-grade" optics for the ALED150 that deliver efficient, clean, uniform light distributions at a reasonable cost. The vacuum-metallized specular reflector creates what is known as "repeatable" optics manufacturing, ensuring consistent, reliable distribution. The optics are factory installed and meet IES Lateral Distribution Types II, III and IV.

For assistance in choosing the distribution to match your application, please contact RAB's Lighting Design department by emailing lightingdesign@rabweb.com or calling 888 722-1000.



Type II

The Type II distribution is ideal for wide walkways, on ramps and entrance roadways, bike paths and other long and narrow lighting applications. Meant for lighting larger areas and usually located near the roadside, this type of lighting is commonly found on smaller side streets or jogging paths.



ALED2T150 Mounted at 25 ft.

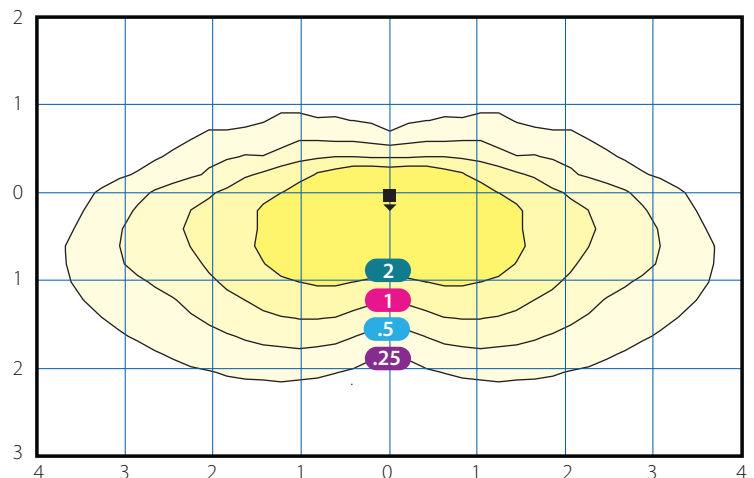

Grid Scale: Multiples of Mounting Height • Values shown in Footcandles
Photometric Report #ITL79617

Type III

The Type III distribution is ideal for roadway, general parking, and other area lighting applications where a larger pool of lighting is required. It is intended to be located near the side of the area, allowing the light to project outward and fill the area.



ALED3T150 Mounted at 25 ft.

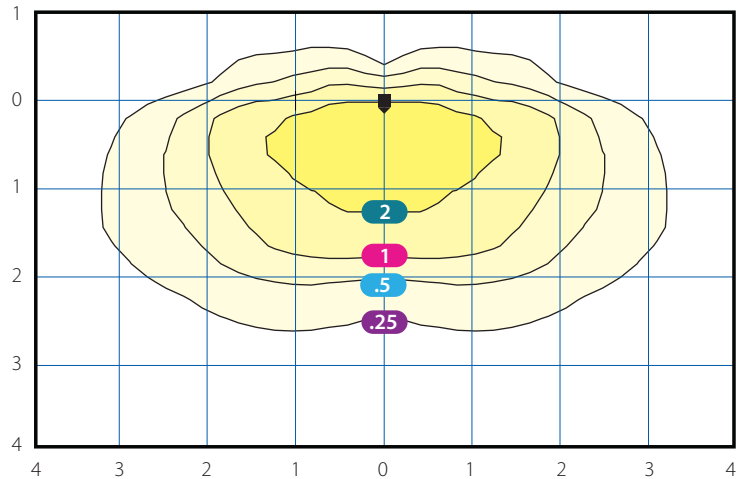

Grid Scale: Multiples of Mounting Height • Values shown in Footcandles
Photometric Report #ITL79623

Type IV

The Type IV distribution (also known as a “Forward Throw”) is especially suited for mounting on the sides of buildings and walls, and for illuminating the perimeter of parking areas. It produces a semicircular distribution with essentially the same candlepower at lateral angles from 90 to 270 degrees.



ALED4T150 Mounted at 25 ft.

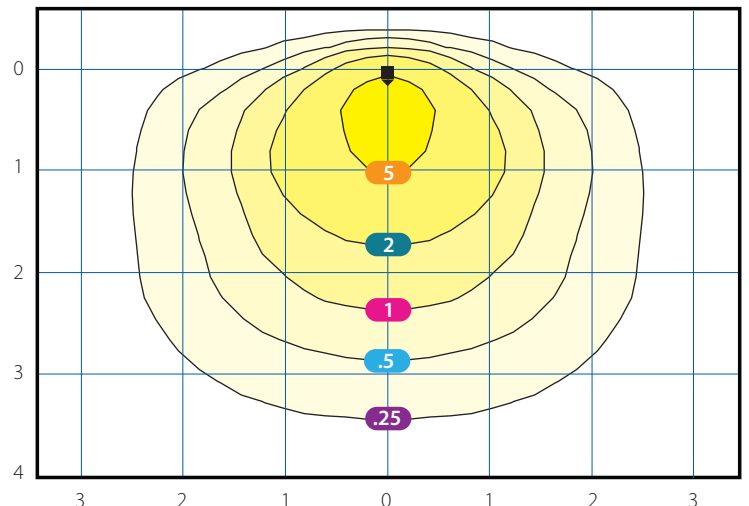

Grid Scale: Multiples of Mounting Height • Values shown in Footcandles
Photometric Report #ITL79629

ALED150

- Replaces 400W MH area lights
- 66% energy cost savings vs. HID
- 100,000-hour LED lifespan
- Type II, III and IV distribution (also available as a wallpack)
- Slipfitter mounting available
- Bi-level operation (optional)
- Various photocell options available
- 5-Year Warranty

Specifications

UL Listing: Suitable for wet locations.

LEDs: Multi-chip, high-output, long-life LEDs

Lifespan: 100,000-hour LED lifespan based on IES LM-80 results and TM-21 calculations

Driver(s): Class 2, 2000mA, 100 - 277V and 480V, 50/60 Hz, Surge protection 4 kV

Bi-Level Operation (optional): Allows 50% and 100% output modes

Dimming: Available as On/Off or with 0-10V dimming driver (*all models except the ALED105 family*)

Cold Weather Starting: The minimum starting temperature is -40°C.

Thermal Management: Superior thermal management with external Air-Flow fins

Housing: Die-cast aluminum housing, lens frame and mounting arm

Mounting: Heavy-duty, with "O" ring seal & stainless steel screws

Gaskets: High-temperature silicone gaskets

Color Consistency: 7-step MacAdam Ellipse binning to achieve consistent fixture-to-fixture color

Color Stability: LED color temperature is warranted to shift no more than 200K in CCT over a 5 year period.

Color Uniformity: RAB's range of CCT (Correlated Color Temperature) follows the guidelines of the American National Standard for Specifications for the Chromaticity of Solid State Lighting (SSL) Products, ANSI C78.377-2011.

Reflector: Specular vacuum-metallized polycarbonate

Finish: Our environmentally friendly polyester powder coatings are formulated for high-durability and long-lasting color, and contain no VOC or toxic heavy metals.

Green Technology: Mercury and UV free, and RoHS compliant. Polyester powder coat finish formulated without the use of VOC or toxic heavy metals.

IESNA LM-79 & LM-80 Testing: RAB LED luminaires have been tested by an independent laboratory in accordance with IESNA LM-79 and LM-80, and have received the Department of Energy "Lighting Facts" label.

California Title 24: ALED150 complies with California Title 24 building and electrical codes.

Dark Sky Approved: The International Dark Sky Association has approved this product as a full cutoff, fully shielded luminaire.

For use on LEED Buildings: IDA Dark Sky Approval means that this fixture can be used to achieve LEED Credits for Light Pollution Reduction.

Performance*

Cool Light (5000K)

Nominal Watts @ 120V	78W	105W	125W	150W
Output Lumens	7564	10,384	12,805	14,349
Lumens Per Watt	96	98	94	92
Color Accuracy (CRI)	67	65	65	65

Neutral Light (4000K)

Nominal Watts @ 120V	78W	105W	125W	150W
Output Lumens	6673	8790	10,952	11,786
Lumens Per Watt	84	83	80	76
Color Accuracy (CRI)	82	82	82	82

Warm Light (3000K)

Nominal Watts @ 120V	78W	105W	125W	150W
Output Lumens	5968	8461	10,464	11,352
Lumens Per Watt	75	80	77	74
Color Accuracy (CRI)	82	81	81	81

* Values shown for Type IV. Visit rabweb.com for Type II and III.

Accessories

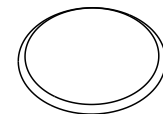

Button Photocell
(not available for slipfitter mount)

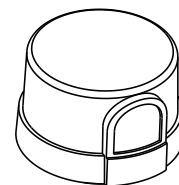

Twistlock Photocell
(not available for slipfitter mount)

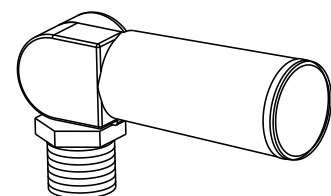

Swivel Photocell

Dimensions & Weight

POLE MOUNT - Weight: 30 lbs. **EPA:** 0.75

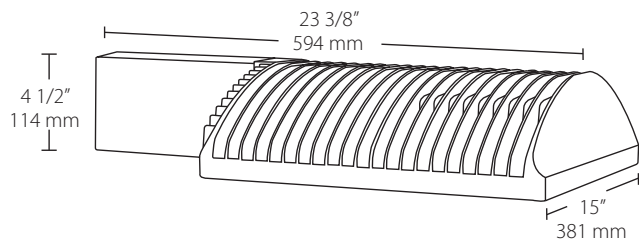

WALLPACK - Weight: 34.8 lbs.

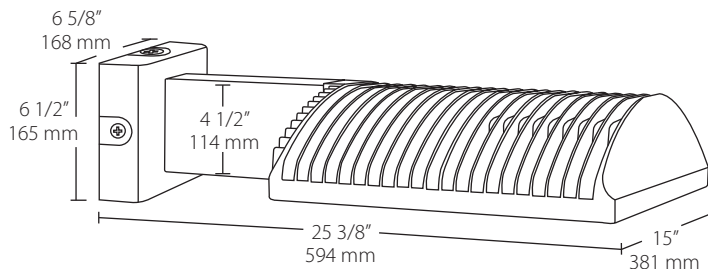

SLIPFITTER - Weight: 32 lbs. **EPA:** 2.2

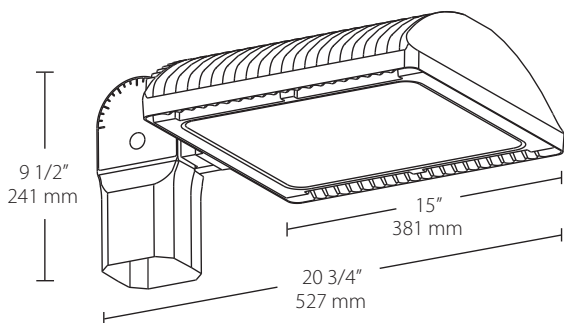

WALLPACK (NO ARM) - Weight: 26 lbs.

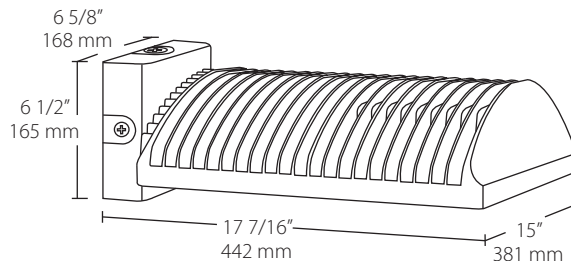

Ordering Information

Product Family	Optics	Wattage	Mounting	Color Temp	Finish Color	Driver Options	Photocell Options
ALED							
2T Type II		50 50W	Blank Pole mount	Blank 5000K	Blank Bronze	/480 480V	/PC 120V*
3T Type III		78 78W	SF Slipfitter	N 4000K	RG Gray	/BL Bi-Level	/PC2 277V*
4T Type IV		105 105W		Y 3000K	W White	/D10 0 - 10V Dimming	/PCT 120-277V Twistlock*
		125 125W			K Black		/PCT4 480V Twistlock*
		150 150W					/PCS 120V Swivel
							/PCS2 277V Swivel
							/PCS4 480V Swivel
							/WS2 Multi-level motion** sensor (20 ft. mt. ht.)
							/WS4 Multi-level motion** sensor (40 ft. mt. ht.)

*Pole mount models only.

**Only available with 0 - 10V dimming models.

Product Family	Optics	Wattage	Color Temp	Mounting	Finish Color	Driver Options	Photocell Options
WPLED							
2T Type II		50 50W	Blank 5000K	Blank Arm	Blank Bronze	/480 480V	/PC 120V
3T Type III		78 78W	N 4000K	FX No Arm	W White	/BL Bi-Level	/PC2 277V
4T Type IV		105 105W	Y 3000K			/D10 0 - 10V Dimming	/PCT 120-277V Twistlock
		125 125W					/PCT4 480V Twistlock
		150 150W					/PCS 120V Swivel
							/PCS2 277V Swivel
							/PCS4 480V Swivel
							/WS2 Multi-level motion** sensor (20 ft. mt. ht.)
							/WS4 Multi-level motion** sensor (40 ft. mt. ht.)

**Only available with 0 - 10V dimming models.



Please visit rabweb.com to see which products are DLC listed.