

# INSTRUCTIONS

## TOS TAPE LIGHT INSTALLATION

# RAB®

RAB Lighting is committed to creating high-quality, affordable, well-designed and energy-efficient LED lighting and controls that make it easy for electricians to install and end users to save energy. We'd love to hear your comments. Please call the Marketing Department at 888-RAB-1000 or email: [marketing@rablighting.com](mailto:marketing@rablighting.com)

**\*\* DON'T TOSS IT—RECYCLE IT! MAKE THE SUSTAINABLE CHOICE BY RECYCLING THIS FIXTURE AT END OF LIFE WITH A LICENSED RECYCLING PROVIDER. \*\***



TOSYY, TOSY, TOSN



TOS/LCB



TOS/RGB

## IMPORTANT

### READ CAREFULLY BEFORE INSTALLING FIXTURE. RETAIN THESE INSTRUCTIONS FOR FUTURE REFERENCE.

RAB fixtures must be wired in accordance with the National Electrical Code and all applicable local codes. Proper grounding is required for safety. THIS PRODUCT MUST BE INSTALLED IN ACCORDANCE WITH THE APPLICABLE INSTALLATION CODE BY A PERSON FAMILIAR WITH THE CONSTRUCTION AND OPERATION OF THE PRODUCT AND THE HAZARDS INVOLVED.

1. The operation instruction does not supersede federal, state, local, or (*inter*) national laws, regulations, rules, ordinances, and codes that may apply to electrical installations.
2. The installation and electrical connection process must be operated by a professional electrician using the applicable and appropriate electrical codes.
3. Installation, usage and storage must occur in the environment within the temperature range (*usually -20~45°C for installation & usage and -20~60°C for storage*) indicated on the product datasheet of the tape light.
4. Make sure the operating voltage of the tape light coincides with the voltage of the extra LED power supply certified for the LED lighting industry, do not connect the tape light directly to the AC power such as 120V input.
5. Please choose the suitable waterproof rating of the tape light according to the actual application scene.
6. Unroll the tape light from reel before illumination, to avoid product damage caused by the heat.
7. The tape light can be cut into certain shorter lengths, and also can be spliced into longer lengths. Please refer to the standard length and increment written on the product datasheet of the tape light. Beyond working length will lead to quality issues like overload, uneven brightness, etc.
8. Turn off the power supply before wiring, assembly, processing, cleaning, maintenance, etc, and ensure all wiring and polarities are correct before powering on.
9. Do not secure the tape light with staples, nails, or similar objects that can damage the insulated housing for waterproofing.
10. Be aware of ESD protection, handle with care without colliding or crushing, do not mechanically press down on LED and other components, and do not cover the tape light with heat insulation gasket material.
11. Try to use in a well ventilated environment and avoid complete sealing. Avoid installing and using the tape light near heat sources, or other potentially dangerous sources like corrosive solvents.
12. To protect your eyes, do not stare at the light for a long time when illuminating the tape light.
13. An additional heat sink is helpful for the heat conductivity and LED lifetime, please refer to the heat sink and LED lifespan definition on the product datasheet of the tape light.
14. To reduce the voltage drop as much as possible, the wire length between tape light and power supply should be as short as possible.
15. Considering the reliability of the LED power supply, it's recommended to use the loading powers not exceed 80% of its rated output power.
16. Make sure that the LED power supply does not generate reverse voltage, it will damage the tape light.
17. Dust and dirt accumulated over time should be removed from the light emitting surface to assure optimal functioning of the tape light. Disconnect the power before maintenance and cleaning.
18. Paints, solvents and corrosive cleaning chemicals may not contact and thus affect the tape light.
19. This product may not be treated as household waste, dispose of the material through the waste recycling of electrical and electronic equipment.
20. CAUTION: The mounting means provided with this tape light has not been evaluated for reliability. If installed where failure of the mounting means could cause injury to persons or damage to property below, supplemental means of securement should be considered.

# INSTRUCTIONS

## TOS TAPE LIGHT INSTALLATION



RAB Lighting is committed to creating high-quality, affordable, well-designed and energy-efficient LED lighting and controls that make it easy for electricians to install and end users to save energy. We'd love to hear your comments. Please call the Marketing Department at 888-RAB-1000 or email: [marketing@rablighting.com](mailto:marketing@rablighting.com)  
\*\* DON'T TOSS IT—RECYCLE IT! MAKE THE SUSTAINABLE CHOICE BY RECYCLING THIS FIXTURE AT END OF LIFE WITH A LICENSED RECYCLING PROVIDER. \*\*

### WARNING



#### SHOCK HAZARD! IT MAY RESULT IN SERIOUS INJURY OR DEATH!

Do not connect the tape light directly to the high voltage power. Please turn off the power prior to installation.

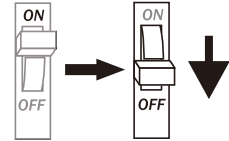
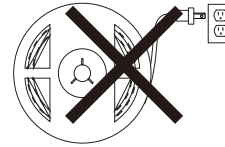

#### HANDLE PRODUCT WITH CARE!

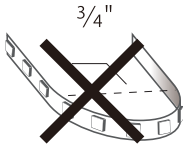

Do not bend the tape light to a radius less than 0.79 inches. In addition, the bending position should avoid electronic components to prevent damage.



Do not bend the tape light on a horizontal plane.



Do not cover the tape light with any materials.



Do not fold, crease the tape light.

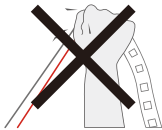

Do not pull the tape light or driver wire hard during installation and using.



Do not rub the tape light with other objects.



Do not twist the tape light.



Do not put excessive pressure on surface of the tape light (*glass/acrylic panes, etc.*)

# INSTRUCTIONS

## TOS TAPE LIGHT INSTALLATION



RAB Lighting is committed to creating high-quality, affordable, well-designed and energy-efficient LED lighting and controls that make it easy for electricians to install and end users to save energy. We'd love to hear your comments. Please call the Marketing Department at 888-RAB-1000 or email: [marketing@rablighting.com](mailto:marketing@rablighting.com)  
\*\* DON'T TOSS IT—RECYCLE IT! MAKE THE SUSTAINABLE CHOICE BY RECYCLING THIS FIXTURE AT END OF LIFE WITH A LICENSED RECYCLING PROVIDER. \*\*

## INSTALLATION

### Option 1: Fixed by adhesive tape.

1. Clean the mounting surface by removing any dirt, debris, or moisture.

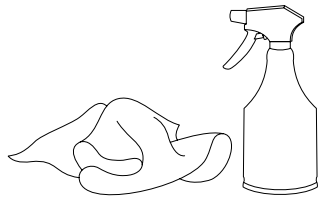

2. Peel off the release paper of the adhesive tape, and then stick the LED tape light to the mounting surface, with materials such as glass, aluminum, iron, stainless steel, PC etc. *(Not recommended to stick to low surface energy materials with oil/dust/wax/powder/paint, such as cement, gravel, silicon rubber, rough board etc.)*

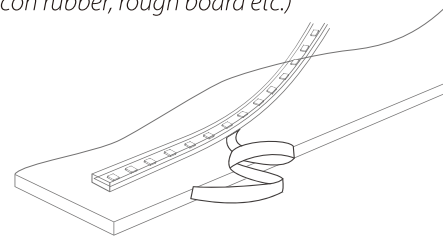

### Option 2: Fixed by clip in TSC2 & TSC3 & TSC5.

1. Place the LED tape light to the mounting surface.

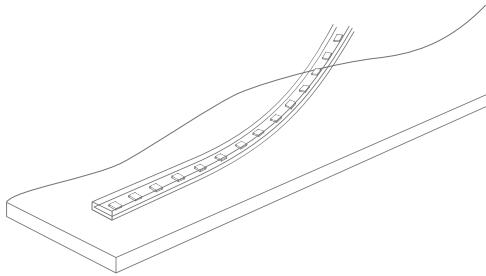

2. Fixed the LED tape light by clip and screw.

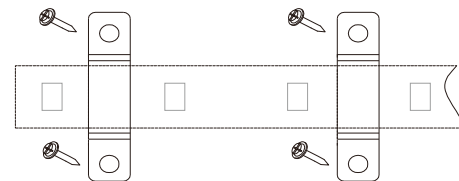

### Option 3: Fixed by aluminum profile in TAP12 & TAP15.

1. Fixed the aluminum profile by clip and screw to the mounting surface, with materials such as wood, metal, plastic etc. *(Not recommended to fix to relatively brittle, hard and soft materials such as glass/stone/ceramic/foam etc.)*

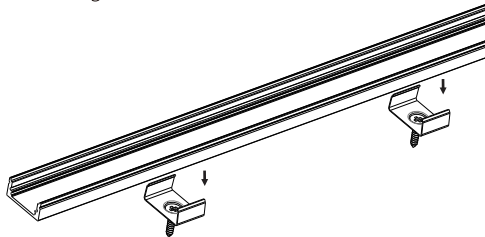

2. Peel off the release paper of the adhesive tape, and then stick the tape light on the aluminum profile.

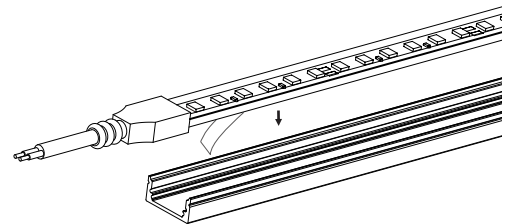

3. Fix the cover into the aluminum profile by gradually pressing in the same direction.

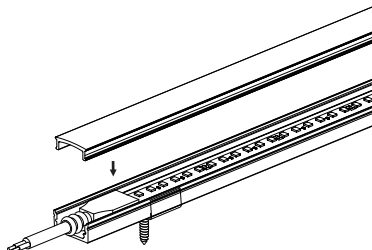

4. Fix the end cap onto the profile.

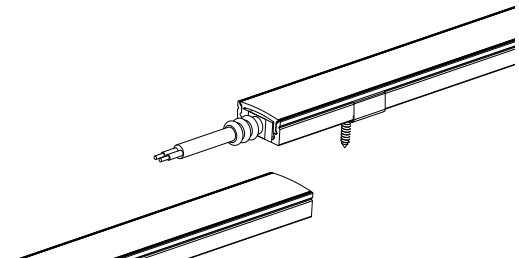

# INSTRUCTIONS

## TOS TAPE LIGHT INSTALLATION



RAB Lighting is committed to creating high-quality, affordable, well-designed and energy-efficient LED lighting and controls that make it easy for electricians to install and end users to save energy. We'd love to hear your comments. Please call the Marketing Department at 888-RAB-1000 or email: [marketing@rablighting.com](mailto:marketing@rablighting.com)  
**\*\* DON'T TOSS IT—RECYCLE IT! MAKE THE SUSTAINABLE CHOICE BY RECYCLING THIS FIXTURE AT END OF LIFE WITH A LICENSED RECYCLING PROVIDER. \*\***

### WIRING for TOSYY, TOSY, TOSN

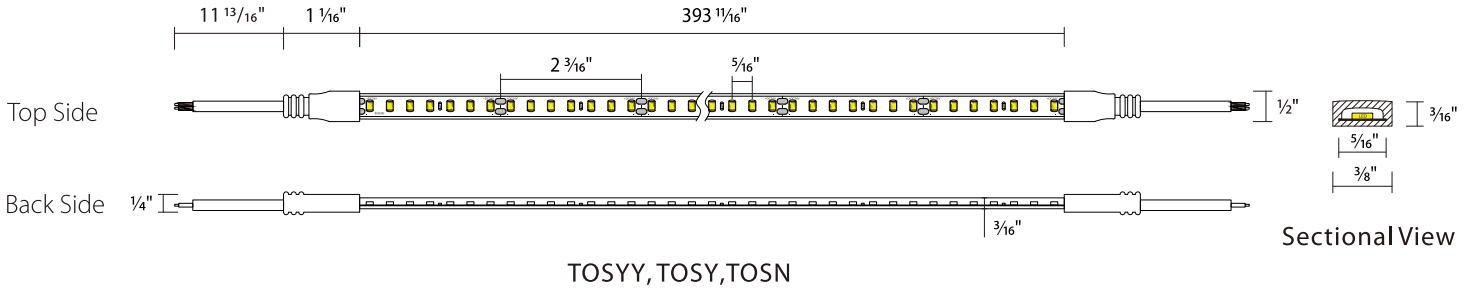

Note:  
 (1) TOSYY, TOSY, TOSN 2-pin wire with color in red (+) / black (-).

Option 1: use TID-60 or TID-96 driver with TRIAC dimming for static white tape lights.

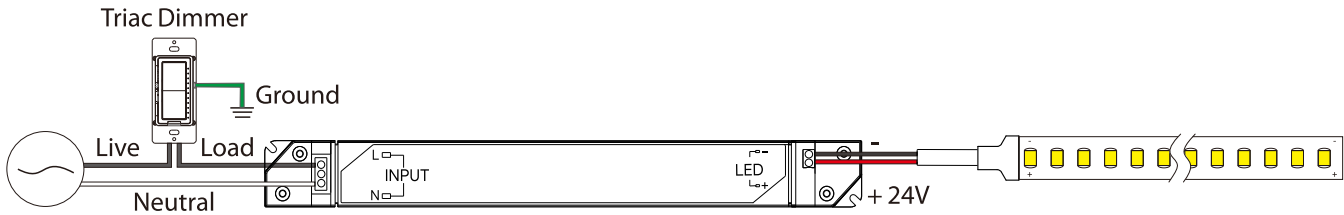

Wire Specification		Value
Input Wire	Gauge	16-20AWG
Output Wire	Gauge	18-22 AWG

- Notes:
- This driver is compatible with both leading edge and trailing edge triac dimmer.
  - This driver should be installed by qualified and professional person.
  - Please make sure the driver is installed in ventilation environment for good heat dissipation.
  - For avoiding driver damage, please make sure the electric wiring is correct before testing.

# INSTRUCTIONS

## TOS TAPE LIGHT INSTALLATION

# RAB

RAB Lighting is committed to creating high-quality, affordable, well-designed and energy-efficient LED lighting and controls that make it easy for electricians to install and end users to save energy. We'd love to hear your comments. Please call the Marketing Department at 888-RAB-1000 or email: [marketing@rablighting.com](mailto:marketing@rablighting.com)  
\*\* DON'T TOSS IT—RECYCLE IT! MAKE THE SUSTAINABLE CHOICE BY RECYCLING THIS FIXTURE AT END OF LIFE WITH A LICENSED RECYCLING PROVIDER. \*\*

## WIRING for TOSYY, TOSY, TOSN

Option 2: use TOD-96 driver with 0-10V/1-10V/10V PWM/Potentiometer dimming for static white tape lights.

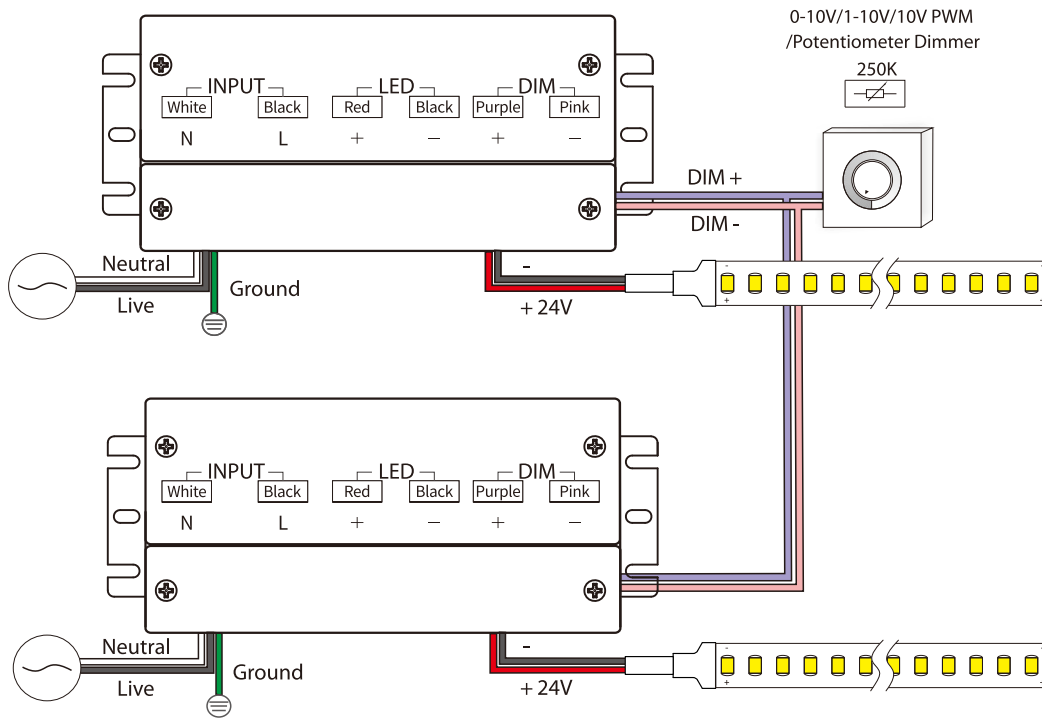

### Notes:

- Dimming interface characteristics: 0.9V and below are closed, 1V is the darkest, 10V is the brightest, 1-10V is the dimming range.
- The dimming interface distinguishes between positive and negative, DIM+ is positive, DIM- is negative, please do not reverse.
- Dimming interface does not support voltage access higher than 20V, otherwise it will cause damage to the internal components.
- When the dimming interface is open, the driver outputs the maximum current. When the interface is short-circuited, the current output is closed.
- When multiple synchronous dimming is required, the positive poles of the dimming interface of each driver are connected together, and the negative poles are connected together.
- Support passive dimmer or isolated active dimmer dimming, does not support non-isolated active dimmer dimming.
- In general, it is recommended that the number of drivers connected in parallel under the same dimmer does not exceed 30pcs, and the Max. wiring length of dimming wires do not exceed 328ft.
- It is recommended that the dimming wires should not be lower than the 22AWG wire.
- Do not put the dimming wires with high voltage or interference sources. If it is unavoidable, please use the shielded wires.
- Although the waterproof level of the LED driver can reach the wet location in IP65, considering the safety of wiring, it is required that the LED driver should not be directly exposed to outdoor environments that are soaked in rain or water, and should be shielded, such as being placed in a power box.

# INSTRUCTIONS

## TOS TAPE LIGHT INSTALLATION



RAB Lighting is committed to creating high-quality, affordable, well-designed and energy-efficient LED lighting and controls that make it easy for electricians to install and end users to save energy. We'd love to hear your comments. Please call the Marketing Department at 888-RAB-1000 or email: [marketing@rablighting.com](mailto:marketing@rablighting.com)  
**\*\* DON'T TOSS IT—RECYCLE IT! MAKE THE SUSTAINABLE CHOICE BY RECYCLING THIS FIXTURE AT END OF LIFE WITH A LICENSED RECYCLING PROVIDER. \*\***

### WIRING for TOSYY, TOSY, TOSN

Option 3: use TOD-96 driver with TRIAC dimming for static white tape lights.

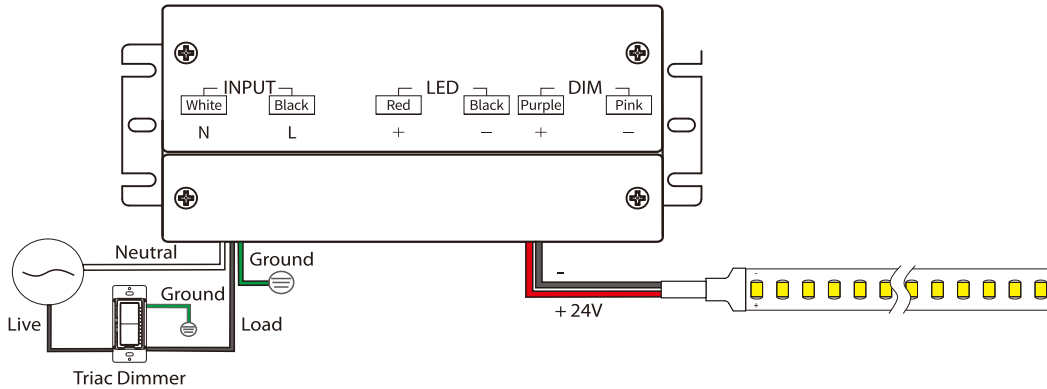

#### Notes:

- This driver is compatible with both leading edge and trailing edge triac dimmer.
- This driver should be installed by qualified and professional person.
- Please make sure the driver is installed in ventilation environment for good heat dissipation.
- For avoiding driver damage, please make sure the electric wiring is correct before testing.
- Although the waterproof level of the LED driver can reach the wet location in IP65, considering the safety of wiring, it is required that the LED driver should not be directly exposed to outdoor environments that are soaked in rain or water, and should be shielded, such as being placed in a power box.

### WIRING for TOS/LCB, TOS/RGB

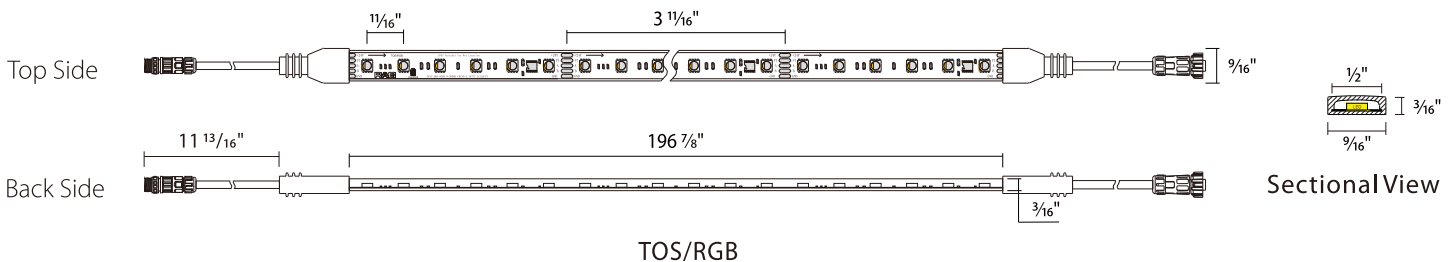
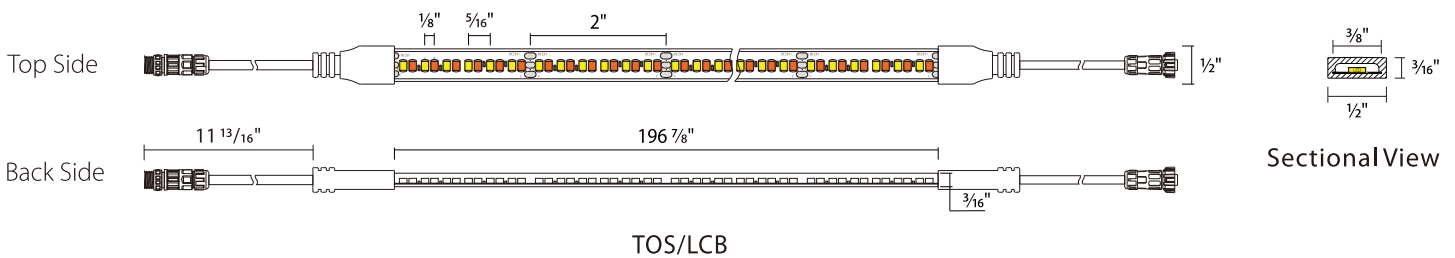

#### Note:

- (1) TOS/LCB 3-pin male/female M12 connector with color in black (+) / yellow (w) / white (c).
- (2) TOS/RGB 5-pin male/female M12 connector with color in black (+) / Green (PI/PO) / red (A) / blue (B) / white (GND).

# INSTRUCTIONS

## TOS TAPE LIGHT INSTALLATION



RAB Lighting is committed to creating high-quality, affordable, well-designed and energy-efficient LED lighting and controls that make it easy for electricians to install and end users to save energy. We'd love to hear your comments. Please call the Marketing Department at 888-RAB-1000 or email: [marketing@rablighting.com](mailto:marketing@rablighting.com)  
 \*\* DON'T TOSS IT—RECYCLE IT! MAKE THE SUSTAINABLE CHOICE BY RECYCLING THIS FIXTURE AT END OF LIFE WITH A LICENSED RECYCLING PROVIDER. \*\*

### WIRING for TOS/LCB, TOS/RGB

TOS/LCB Uses driver TND-96 and controller LCBLV/TW.

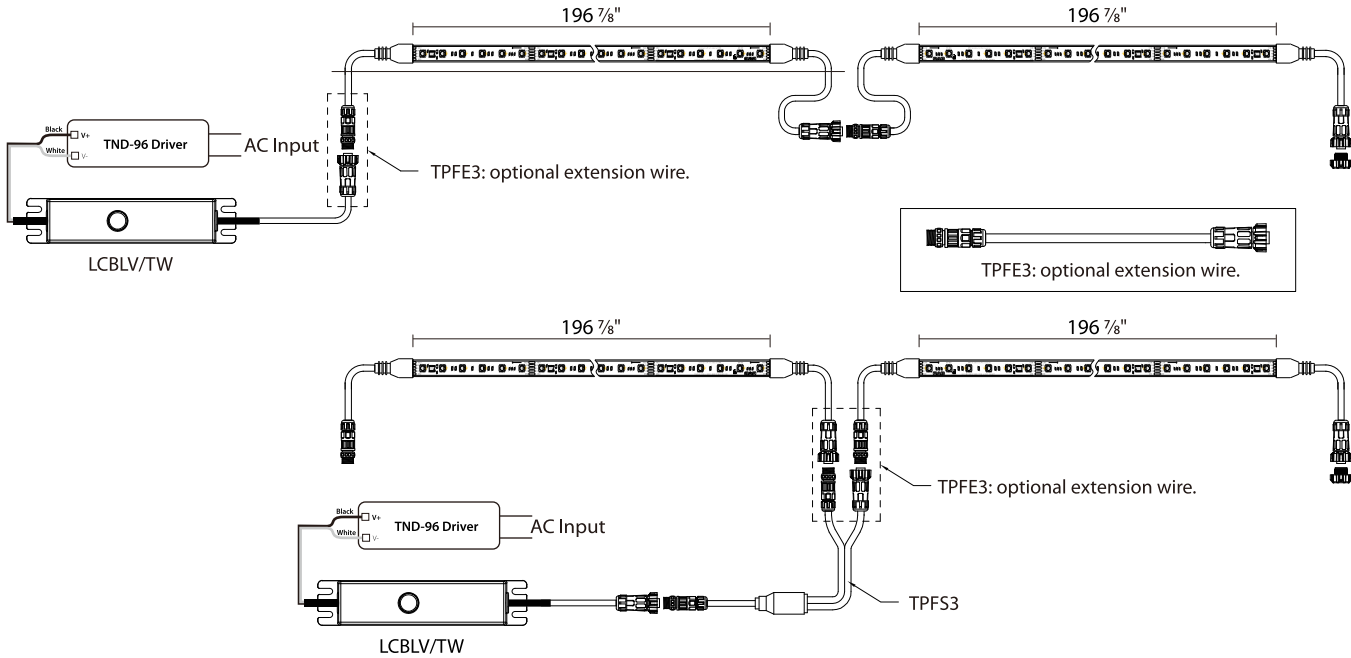

TOS/RGB Uses driver TND-96 and controller LCBLVD/RGB.

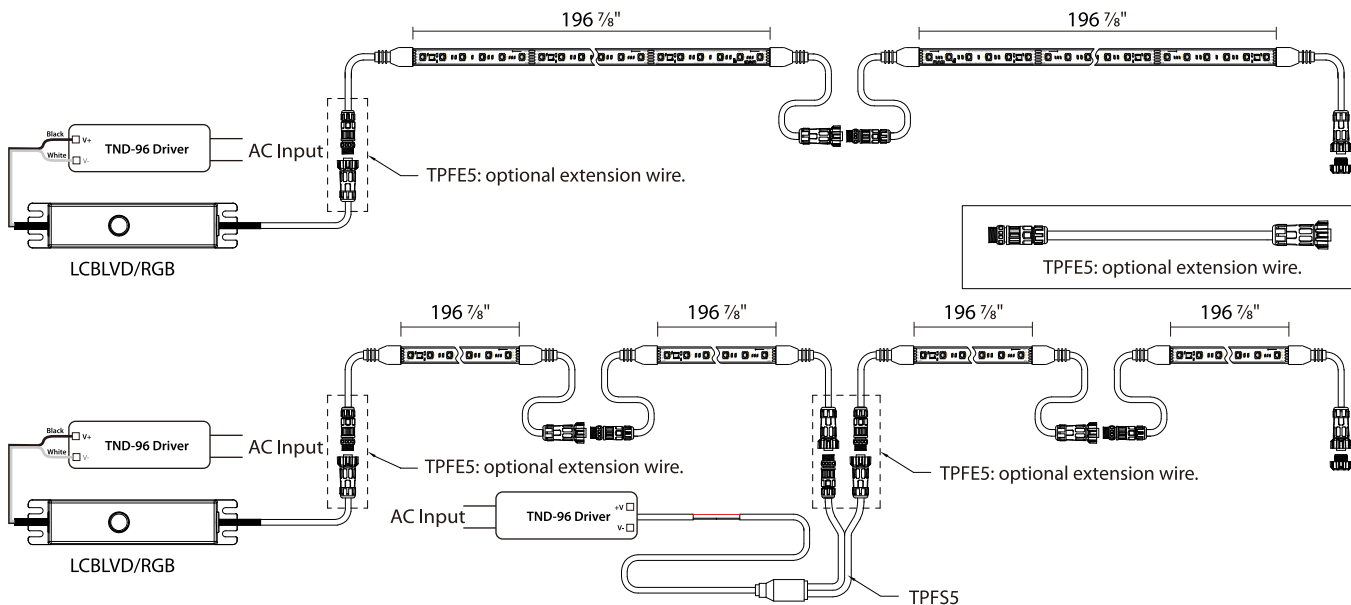

#### Notes:

- This driver and controller should be installed by qualified and professional person.
- Please make sure the driver and controller are installed in ventilation environment for good heat dissipation.
- For avoiding driver damage, please make sure the electric wiring is correct before testing.
- Although the waterproof level of the LED driver can reach the wet location in IP67, considering the safety of wiring, it is required that the LED driver and controller should not be directly exposed to outdoor environments that are soaked in rain or water, and should be shielded, such as being placed in a power box.

# INSTRUCTIONS

## TOS TAPE LIGHT INSTALLATION



RAB Lighting is committed to creating high-quality, affordable, well-designed and energy-efficient LED lighting and controls that make it easy for electricians to install and end users to save energy. We'd love to hear your comments. Please call the Marketing Department at 888-RAB-1000 or email: [marketing@rablighting.com](mailto:marketing@rablighting.com)  
**\*\* DON'T TOSS IT—RECYCLE IT! MAKE THE SUSTAINABLE CHOICE BY RECYCLING THIS FIXTURE AT END OF LIFE WITH A LICENSED RECYCLING PROVIDER. \*\***

### ASSEMBLY

**Option 1: Using the soldering-free connector in TOJ2, TOJ3, TOJ5 (IP65 [Wet] after the processing of connector splicing and sealant applying).**

1. Cut along the edge of the solder pad and make sure the connector contact end needs to retain the complete solder pad.\*
2. Peel off the adhesive tape on bottom.
3. Insert the transparent cap into the tape light with the notch facing downward.

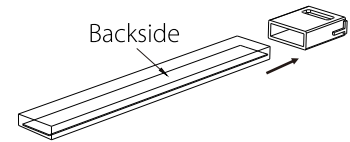
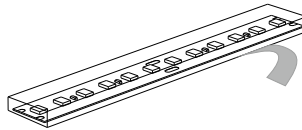
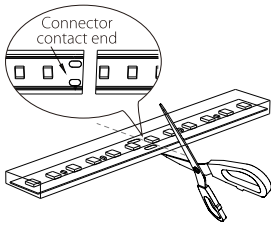

4. Press the milky cap onto the transparent cap with its gap being aligned with the protrusion. (The connector's positive and negative terminals must align with those on the LED strip.)
5. Make sure it's will assembled by pressing the milky cap firmly to the bottom with pliers. (Same operation for the connector type of tape light-to-wire-to-tape light)
6. Same operation for the connector type of tape light-to-tape light. (Ensure that the two tape lights and their transparent caps are completely close together before installing the milky cap.)

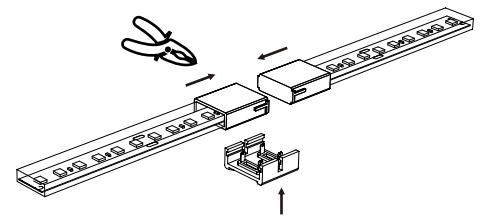
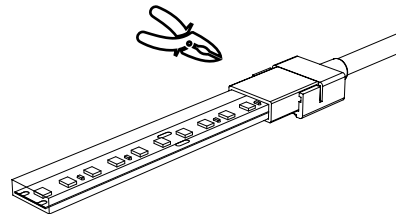
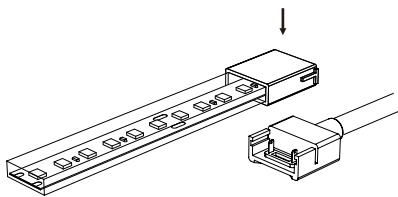

7. Apply the glue to the corresponding position, for connector types of tape light-to-wire and tape light-to-wire-to-tape light.\*
8. Apply the glue to the corresponding position, for connector type of tape light-to-tape light.
9. Notes: Both the connector and the tape light have polarity markings. Please check carefully and ensure the accuracy of the polarity connection at all times during assembly.

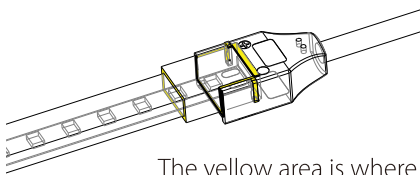

The yellow area is where glue needs to be applied.

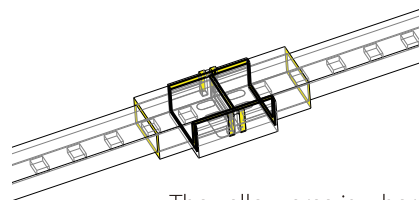

The yellow area is where glue needs to be applied.

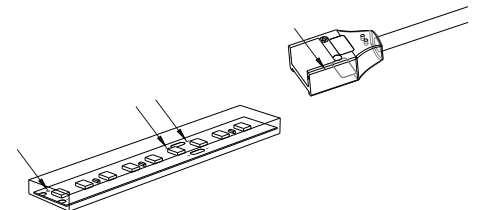

#### Notes:

- 1.It is necessary to sacrifice one cut to ensure the integrity of the solder pad for connector adaptation.
- 2.The TOJ5 series is not available with a light-to-wire type connector.

# INSTRUCTIONS

## TOS TAPE LIGHT INSTALLATION

# RAB®

RAB Lighting is committed to creating high-quality, affordable, well-designed and energy-efficient LED lighting and controls that make it easy for electricians to install and end users to save energy. We'd love to hear your comments. Please call the Marketing Department at 888-RAB-1000 or email: [marketing@rablighting.com](mailto:marketing@rablighting.com)  
\*\* DON'T TOSS IT—RECYCLE IT! MAKE THE SUSTAINABLE CHOICE BY RECYCLING THIS FIXTURE AT END OF LIFE WITH A LICENSED RECYCLING PROVIDER. \*\*

### Option 2: Apply the wire soldering in TPF2, TPF3, TPF5.

1. Cut the tape light along the cutting line to be the desired length.

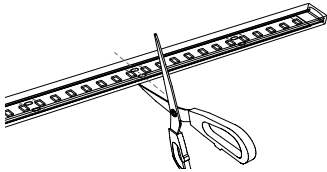

2. Cut off some parts of upper silicone jacket in 3mm long carefully, until these upper solder pads on PCB are exposed.

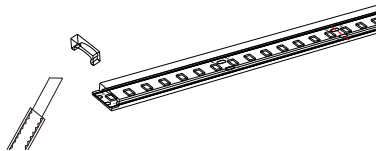

3. Clean the solder pads thoroughly. Be careful not to damage the PCB.

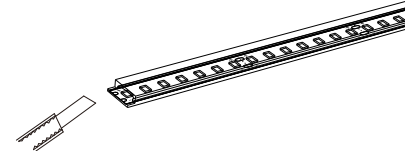

4. Solder the wire cable to the upper solder pads on PCB.

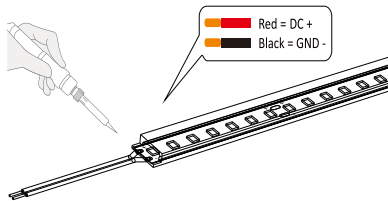

5. Fill the inner part of front cap by silicone glue and then seal it to the LED tape light.

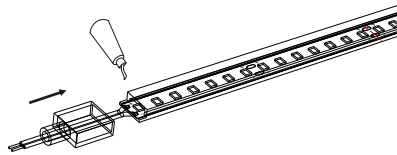

6. Fill the inner part of end cap by silicone glue and then seal it to the LED tape light.

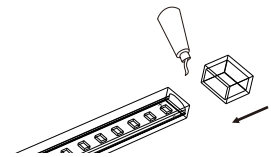

# INSTRUCTIONS

## TOS TAPE LIGHT INSTALLATION



RAB Lighting is committed to creating high-quality, affordable, well-designed and energy-efficient LED lighting and controls that make it easy for electricians to install and end users to save energy. We'd love to hear your comments. Please call the Marketing Department at 888-RAB-1000 or email: [marketing@rablighting.com](mailto:marketing@rablighting.com)  
**\*\* DON'T TOSS IT—RECYCLE IT! MAKE THE SUSTAINABLE CHOICE BY RECYCLING THIS FIXTURE AT END OF LIFE WITH A LICENSED RECYCLING PROVIDER. \*\***

### Accessory Compatibility List

Tape Light Family	Acc CAT Nos	Acc Description
TOSYY, TOSY, TOSN	TPF2	2pin Power feed kit for IP67 PCB W=8mm SMD Tape Light
	TSG	Silicon glue 10ml per unit, for TPF or TOJ or TOCJ
	TOJ2	2pin PCB W=8mm outdoor connector kits
	TSC2	Silicon mounting clips for PCB W=8mm waterproof Tape Light
	TAP15	15.5mm wide aluminal channel kits
	TID-60	60W indoor driver( <i>for indoor only</i> )
	TID-96	96W indoor driver( <i>for indoor only</i> )
	TID/B	J-box for TID Drivers
	TOD-96	96W outdoor LED driver 5in1 dimming
TOS/LCB	TPF3	3pin Power feed kit with M12 Connector L=1FT for IP67 PCB W=10mm SMD Tape Light
	TPFE3	3pin Power Extender with M12 Connector L=8FT for 3pin Tape Light
	TPFS3	3pin Wire Splitter with M12 Connector L=1.5FT for 3pin Tape Light
	TSG	Silicon glue 10ml per unit, for TPF or TOJ or TOCJ
	TOJ3	3pin PCB W=10mm outdoor connector kits
	TSC3	Silicon mounting clips for PCB W=10mm waterproof Tape Light
	TAP15	15.5mm wide aluminum channel kits
	TND-96	96W outdoor ON/OFF LED driver
	TND/B	J-box for TND Drivers
TOS/RGB	TPF5	5pin Power feed kit with M12 Connector L=1FT for IP67 PCB W=12mm SMD Tape Light
	TPFE5	5pin Power Extender with M12 Connector L=8FT for 5pin Tape Light with white Connector
	TPFS5	5pin Wire Splitter with M12 Connector L=1.5FT for 5pin Tape Light
	TSG	Silicon glue 10ml per unit, for TPF or TOJ or TOCJ
	TOJ5	5pin PCB W=10mm outdoor connector kits
	TSC5	Silicon mounting clips for PCB W=12mm waterproof Tape Light
	TAP15	15.5mm wide aluminum channel kits
	TND-96	96W outdoor ON/OFF LED driver
	TND/B	J-box for TND Drivers