

INSTRUCTIONS

FFLED18 INSTALLATION

RAB®

RAB Lighting is committed to creating high-quality, affordable, well-designed and energy-efficient LED lighting and controls that make it easy for electricians to install and end users to save energy. We'd love to hear your comments. Please call the Marketing Department at 888-RAB-1000 or email: marketing@rablighting.com



IMPORTANT

READ CAREFULLY BEFORE INSTALLING FIXTURE. RETAIN THESE INSTRUCTIONS FOR FUTURE REFERENCE.

RAB fixtures must be wired in accordance with the National Electrical Code and all applicable local codes. Proper grounding is required for safety. THIS PRODUCT MUST BE INSTALLED IN ACCORDANCE WITH THE APPLICABLE INSTALLATION CODE BY A PERSON FAMILIAR WITH THE CONSTRUCTION AND OPERATION OF THE PRODUCT AND THE HAZARDS INVOLVED.

WARNING: Make certain power is OFF before installing the fixture. No user serviceable parts inside.

MOUNTING

1. Seal arm thread using Teflon tape or silicone sealant.
2. Secure the LED flood to a 1/2" NPS hole in a junction box or landscape post.
3. Plug all unused holes and seal threads with silicone.
4. The swivel arm on the LED flood allows 140° - 150° of vertical aiming adjustment depending on mounting location.

0-10V DIMMABLE WIRING

Universal voltage driver permits operation at 120V thru 277V, 50 or 60 Hz., except fixtures factory ordered with a 120V swivel photocell (/PCS), 277V swivel photocell (/PCS2). For 0-10V dimming, **Fig. 1**.

1. For Junction Box Mount, feed wires through silicone wiring plug into the junction box.
2. Connect the black fixture lead to the LINE supply lead.
3. Connect the white fixture lead to the COMMON supply lead.
4. Connect the GROUND wire from fixture to supply ground. Do NOT connect the GROUND of the dimming fixture to the output.
5. Connect the purple fixture lead to the DIM V+ lead.
6. Connect the gray fixture lead to the DIM V- lead.
7. Cap the yellow fixture lead, if present. Do NOT connect.

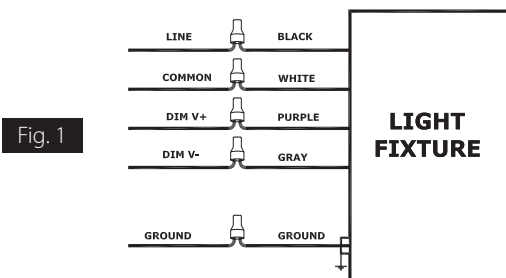

GUARD OR SHIELD INSTALLATION

Wire Guard and Poly Shield mount with (4) #8-32 **Stainless Steel Screws**. Screws are provided with accessory. See **Figure 2** for Guard. See **Figure 3** for Shield.

1. Line up guard with pre-existing, pre-drilled holes in frame as shown, tighten screws.

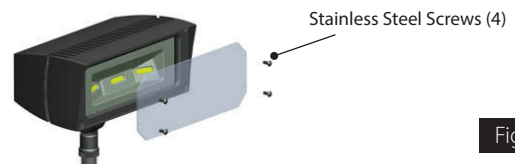
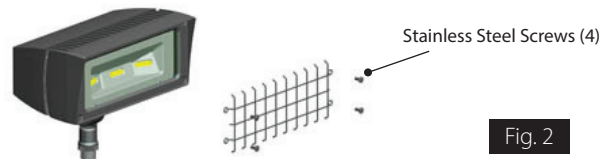

GUARD & SHIELD INSTALLATION

The Wire Guard and Poly Shield can be mounted on the same fixture with (4) #8-32 screws as shown below.

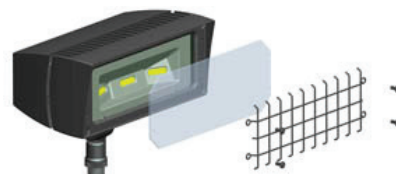

INSTRUCTIONS

FFLED18 INSTALLATION



RAB Lighting is committed to creating high-quality, affordable, well-designed and energy-efficient LED lighting and controls that make it easy for electricians to install and end users to save energy. We'd love to hear your comments. Please call the Marketing Department at 888-RAB-1000 or email: marketing@rablighting.com

CLEANING & MAINTENANCE

CAUTION: Be sure fixture temperature is cool enough to touch. Do not clean or maintain while fixture is energized.

1. Clean glass lens with non-abrasive glass cleaning solution.
2. Do not open the fixture to clean the LED. Do not touch the LED.

TROUBLESHOOTING

1. Check that the line voltage at the fixture is correct. Refer to wiring directions.
2. Be sure the fixture is grounded properly.
3. Is the photocell, if used, functioning properly?

ACCESSORIES & REPLACEMENT PARTS

Chrome Wire Guard:	GDDFFLED18W
Poly shield:	GDDFFLED18P
Lens & Door Replacement:	LFFLED18 (bronze) LFFLED18W (white)

Note: These instructions do not cover all details or variations in equipment nor do they provide for every possible situation during installation, operation or maintenance.



Easy Answers

rablighting.com
Visit our website for product info

Tech Help Line
Call our experts: 888 722-1000

e-mail
Answered promptly - sales@rablighting.com

Free Lighting Layouts
Answered online or by request

INSTRUCTIONS

FFLED INSTALLATION

RAB®

RAB Lighting is committed to creating high-quality, affordable, well-designed and energy-efficient LED lighting and controls that make it easy for electricians to install and end users to save energy. We'd love to hear your comments. Please call the Marketing Department at 888-RAB-1000 or email: marketing@rablighting.com



IMPORTANT

READ CAREFULLY BEFORE INSTALLING FIXTURE. RETAIN THESE INSTRUCTIONS FOR FUTURE REFERENCE.

RAB fixtures must be wired in accordance with the National Electrical Code and all applicable local codes. Proper grounding is required for safety. THIS PRODUCT MUST BE INSTALLED IN ACCORDANCE WITH THE APPLICABLE INSTALLATION CODE BY A PERSON FAMILIAR WITH THE CONSTRUCTION AND OPERATION OF THE PRODUCT AND THE HAZARDS INVOLVED.

WARNING: Make certain power is OFF before installing the fixture. No user serviceable parts inside.

ARM MOUNTING

1. Seal arm thread using Teflon tape or silicone sealant.
2. Secure the LED flood to a 1/2" NPS hole in a junction box or landscape post. Heavy duty XC1 cover provided.
3. Plug all unused holes and seal threads with silicone.
4. The swivel arm on the LED flood allows 180° of vertical aiming adjustment depending on mounting location.

SLIPFITTER MOUNTING

1. The slipfitter mounting fits a 2 3/8" O.D. **Tennon**. Place the slipfitter over the **Tennon** and secure the fixture with the two **Set Screws** on the side of the slipfitter.
2. Remove two screws and plug on side of **Round Cover Plate**. Remove the **Round Cover Plate** and adjust the angle of the fixture.
3. Loosen the **Locking Bolt** and swivel fixture to desired angle.
4. Tighten the **Locking Bolt** and re-attach **Round Cover Plate**.

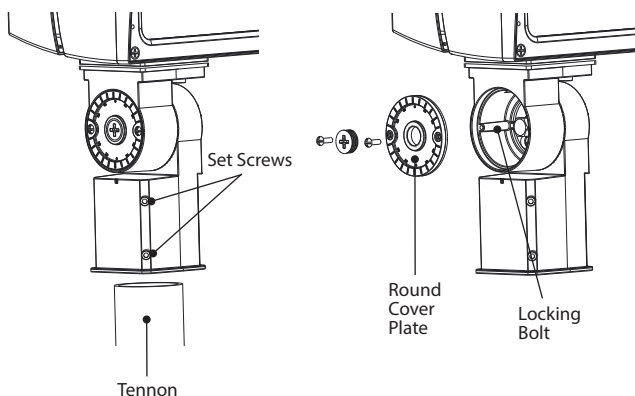

TRUNNION MOUNTING

CAUTION: UL and C-UL listed or CSA certified liquid tight cord grip suitable for use with three conductor type STW flexible cord shall be used for connection to a wet location outlet box provided by others.

1. Loosen the **Pivot Bolts** & angle locking screw.
2. Adjust fixture to desired angle.
3. Tighten **Pivot Bolts** & angle locking screw.

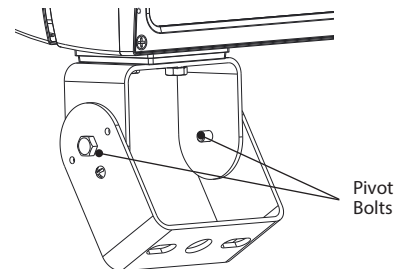

GUARD OR SHIELD INSTALLATION

Wire Guard and Poly Shield mount with (4) #8-32 **Stainless Steel Screws**. Screws are provided with accessory. Guard and Shield may be used together. See **Figure 1** for Guard. See **Figure 2** for Shield.

1. Line up guard with pre-existing, pre-drilled holes in frame as shown, tighten screws.

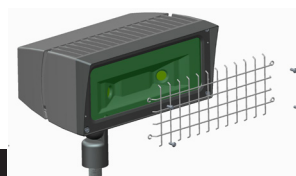

Fig. 1

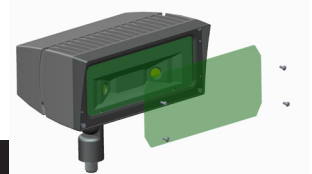

Fig. 2

INSTRUCTIONS

FFLED INSTALLATION



RAB Lighting is committed to creating high-quality, affordable, well-designed and energy-efficient LED lighting and controls that make it easy for electricians to install and end users to save energy. We'd love to hear your comments. Please call the Marketing Department at 888-RAB-1000 or email: marketing@rablighting.com

0-10V DIMMABLE WIRING

Universal voltage driver permits operation at 120V thru 277V, 50 or 60 Hz., except fixtures factory ordered with a 120V swivel photocell (/PCS) and 277V swivel photocell (/PCS2). Units ordered with (/480V) suffix are 480V. For 0-10V dimming, follow the wiring directions below:

1. Connect the black fixture lead to the LINE supply lead.
2. Connect the white fixture lead to the COMMON supply lead.
3. Connect the GROUND wire from fixture to supply ground. Do NOT connect the GROUND of the dimming fixture to the output.
4. Connect the purple fixture lead to the DIM V+ lead.
5. Connect the gray fixture lead to the DIM V- lead.
6. Cap the yellow fixture lead, if present. Do NOT connect.

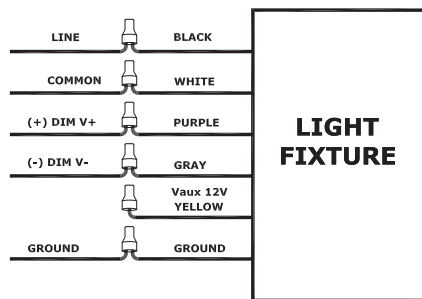

CLEANING & MAINTENANCE

CAUTION: Be sure fixture temperature is cool enough to touch. Do not clean or maintain while fixture is energized.

1. Clean glass lens with non-abrasive glass cleaning solution.
2. Do not open the fixture to clean the LED. Do not touch the LED.

TROUBLESHOOTING

1. Check that the line voltage at the fixture is correct. Refer to wiring directions.
2. Be sure the fixture is grounded properly.
3. Is the photocell, if used, functioning properly?

ACCESSORIES & REPLACEMENT PARTS

Chrome Wire Guard:	GDFLED39W
Poly Shield:	GDFLED39P
Lens & Door Replacement:	LFFLED39 (bronze) LFFLED39W (white)

Note: These instructions do not cover all details or variations in equipment nor do they provide for every possible situation during installation, operation or maintenance.



Easy Answers

rablighting.com
Visit our website for product info

Tech Help Line
Call our experts: 888 722-1000

e-mail
Answered promptly - sales@rablighting.com

Free Lighting Layouts
Answered online or by request