

INSTRUCTIONS

EZPAN® FA 1x4, 2x2, 2x4 INSTALLATION

RAB®

RAB Lighting is committed to creating high-quality, affordable, well-designed and energy-efficient LED lighting and controls that make it easy for electricians to install and end users to save energy. We'd love to hear your comments. Please call the Marketing Department at 888-RAB-1000 or email: marketing@rablighting.com



EZPAN FA 1x4



EZPAN FA 2x2



EZPAN FA 2x4

IMPORTANT

READ CAREFULLY BEFORE INSTALLING FIXTURE. RETAIN THESE INSTRUCTIONS FOR FUTURE REFERENCE.

RAB fixtures must be wired in accordance with the National Electrical Code and all applicable local codes. Proper grounding is required for safety. THIS PRODUCT MUST BE INSTALLED IN ACCORDANCE WITH THE APPLICABLE INSTALLATION CODE BY A PERSON FAMILIAR WITH THE CONSTRUCTION AND OPERATION OF THE PRODUCT AND THE HAZARDS INVOLVED.

WARNING: Make certain power is OFF before installing or maintaining fixture.

WARNING: Risk of fire or electric shock. Suitable for damp locations.

WARNING: Suitable for 9/16" or 15/16" flat tee grid in both insulated ceilings and non-insulated ceilings. Access above ceiling required.

WARNING: Do not handle energized fixture when hands are wet, when standing on wet or damp surfaces, or in water.

WARNING: Vapor barrier must be suitable for 90° C.

WARNING: Fixture to be independently supported to building structure.

RECESSED CEILING MOUNTING

The fixture is suitable only for INDOOR RECESSED CEILING application. Above ceiling access required.

To mount in an insulated or non-insulated ceiling - 9/16" or 15/16" exposed flat tee grid ceiling follow the steps below.

1. Firmly bend the pre-installed **Grid Clips** (up and out as shown in **Fig. 1**.)
2. Rotate and slide the **Fixture** as required to fit through the **Tee-Grid Bar** and place it as indicated by the directional arrow as shown in **Fig. 2**. Secure the **Fixture** to the **Tee-Grid Bar**.
3. Support wires are required by installation codes. Support the **Fixture** to the building structure by **Support Wires** (supplied by others) through the **Grid Clip Hole** as shown in **Fig. 3**.
4. Make sure that the orientation of the **Splice Box** and **Access Plate** faces an accessible tile to make electrical splices.
5. Loosen **Access Plate Screw** and remove the **Access Plate**. Knock out appropriate **Conduit Knockouts** on the **Access Plate** to route input conduit. Use appropriate conduit connectors as required by code (**Fig. 4**).
6. Connect wires as shown in wiring diagram. Push all wires back into the **Splice Box**. Use appropriate UL-approved wire connectors as required by code to complete wiring. Be careful not to pinch wires. **WARNING: To prevent wiring damage or abrasion, do not expose wiring to edges of sheet metal or other sharp objects.**
7. Replace **Access Plate** and tighten **Access Plate Screw**.

Fig. 1

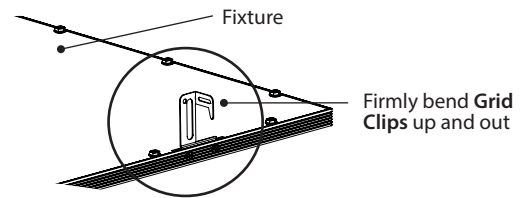

Fig. 2

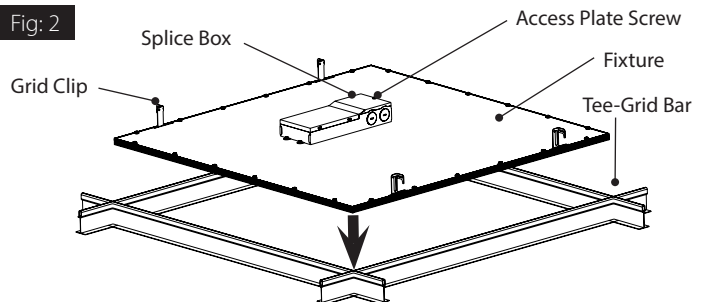

Fig. 3

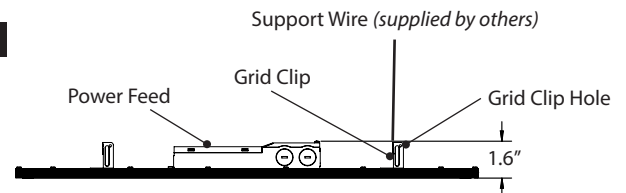
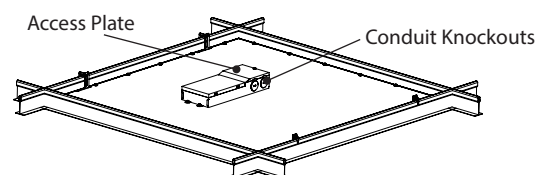

Fig. 4



INSTRUCTIONS

EZPAN® FA 1x4, 2x2, 2x4 INSTALLATION



RAB Lighting is committed to creating high-quality, affordable, well-designed and energy-efficient LED lighting and controls that make it easy for electricians to install and end users to save energy. We'd love to hear your comments. Please call the Marketing Department at 888-RAB-1000 or email: marketing@rablighting.com

0-10V DIMMABLE WIRING

Universal voltage driver permits operation at 120V thru 277V, 50 or 60 Hz. For 0-10V Dimming, follow the wiring directions as in **Fig. 5**.

1. Connect the black fixture lead to the LINE supply lead.
2. Connect the white fixture lead to the COMMON supply lead.
3. Connect the GROUND wire from fixture to supply ground.
4. Connect the purple fixture lead to the (V+) DIM lead.
5. Connect the gray fixture lead to the (V-) DIM lead.

NOTE: Do not connect DIM V+ (purple)/ DIM V- (gray) to line voltage or supply ground.

Fig. 5

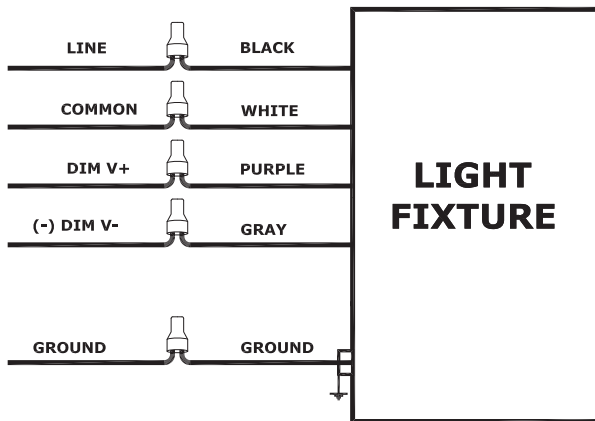

TROUBLESHOOTING

1. Check that the line voltage at fixture is correct. Refer to wiring directions.
2. Be sure the fixture is grounded properly.

CLEANING & MAINTENANCE

CAUTION: Be sure fixture temperature is cool enough to touch. Do not clean or maintain while fixture is energized.

1. Clean polystyrene lens & fixture with non-abrasive cleaning solution.
2. Do not open fixture to clean the LEDs. Do not touch the LEDs.

FIELD ADJUSTMENT

Follow instructions below to change the fixture wattage or color temperature from the factory settings.

Factory Settings: 4000K, 30W (1X4, 2X2), 40W (2X4)

1. Locate the selector switches on the side of the driver.
2. Select a wattage and color temperature by sliding the respective switch up or down to the desired value.
3. After the switches are positioned to the desired settings, insert the silicone cover to lock the switches in place.

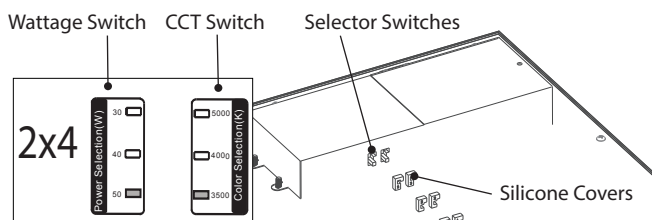

INSTRUCTIONS

EZPAN® FA 1x4, 2x2, 2x4 INSTALLATION



RAB Lighting is committed to creating high-quality, affordable, well-designed and energy-efficient LED lighting and controls that make it easy for electricians to install and end users to save energy. We'd love to hear your comments. Please call the Marketing Department at 888-RAB-1000 or email: marketing@rablighting.com

BATTERY BACKUP MODELS

WIRING

CAUTION: FOR BATTERY BACKUP FIXTURE. Voltage can be present in **BATTERY**. To prevent high voltage from being present on output leads, Inverter connector must be open. Do not join **BATTERY** connector until Installation is complete and AC power is supplied to the emergency driver. (Fig. #6)

NOTE: Make sure that the necessary branch circuit wiring is available. An **UNSWITCHED** AC source of power is required. The emergency driver must be fed from the same branch circuit as the LED driver.

CAUTION: Do not use any supply voltage other than 120-277V 50/60 HZ.

1. Connect **UNSWITCHED HOT** fixture lead to **HOT AC** supply line.
2. If using an **UNSWITCHED** circuit, connect **UNSWITCHED** and **SWITCHED** lines together.
3. If using a **SWITCHED** circuit, connect **SWITCHED HOT** AC fixture lead to the external
4. Connect the gray fixture lead to the (V-) DIM lead.
5. For 0-10V Dimming, connect **DIM (+)** and **DIM (-)** to the supply ground. Do not connect **GROUND** to the output leads.
6. All unused lead must be capped and insulated.
7. After installation is complete, supply AC power to the fixture and connect the **BATTERY**.
8. When power is on, the fixture should be on and the Charging Indicator Light should illuminate to indicate the battery is charging.
9. Once the **BATTERY** has charged for at least one hour, a short duration test may be performed by pressing the test button.
10. After the battery has charged for 24 hours, a long duration test can be performed by shutting power to the fixture.

OPERATION

1. When AC power is applied, the charging indicator light is illuminated, including that the **BATTERY** is being charged.
2. When power fails, the standby power automatically switches to emergency power (internal battery), operating at reduced illumination. The emergency driver supplies power in standby power for a minimum of 90 minutes.
3. When AC power is restored, the emergency driver automatically returns to charging mode.

MAINTENANCE

Although no routine maintenance is required to keep the emergency driver functional, it should be checked periodically to ensure that it is working. The following schedule is recommended:

1. Visually inspect the charging indicator light monthly. It should be illuminated
2. Test the emergency operation of the fixture at 30-day intervals for a minimum of 30 seconds.
3. Conduct a 90-minute discharge test once a year. Fixture would operate at reduced illumination for a minimum of 90 minutes.

TROUBLESHOOTING

1. Is the fixture grounded properly?
2. If the charging indicator light does not illuminate after pressing the test button, check if battery is connected properly.
3. Is the Battery Backup Dip Switch Position set to 4?

FIG. #6

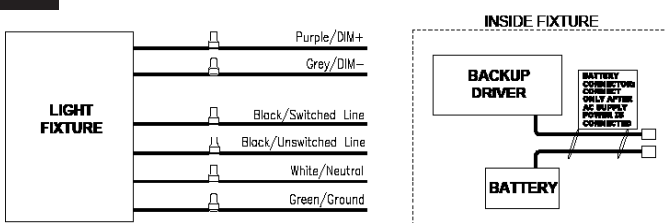

| Battery Backup Setting | | |
|------------------------|----------|---------------------|
| PRODUCT | WATTAGE | DIP SWITCH POSITION |
| EZPANFA1X4 | 25-30-40 | 4 |
| EZPANFA2X2 | 25-30-40 | 4 |
| EZPANFA2X4 | 30-40-50 | 4 |

Note: These instructions do not cover all details or variations in equipment nor do they provide for every possible situation during installation, operation or maintenance.



Easy Answers

rablighting.com
Visit our website for product info

Tech Help Line
Call our experts: 888 722-1000

e-mail
Answered promptly - sales@rablighting.com

Free Lighting Layouts
Answered online or by request