

# INSTRUCTIONS

## FIELD-ADJUSTABLE RBAY17™ INSTALLATION



RAB Lighting is committed to creating high-quality, affordable, well-designed and energy-efficient LED lighting and controls that make it easy for electricians to install and end users to save energy. We'd love to hear your comments. Please call the Marketing Department at 888-RAB-1000 or email: marketing@rablighting.com



RBAY17S

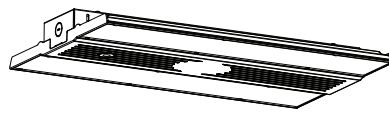

RBAY17M

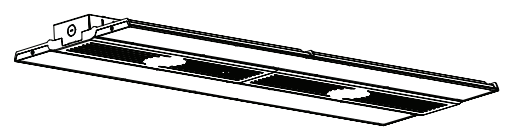

RBAY17L

### IMPORTANT

#### READ CAREFULLY BEFORE INSTALLING FIXTURE. RETAIN THESE INSTRUCTIONS FOR FUTURE REFERENCE.

RAB fixtures must be wired in accordance with the National Electrical Code and all applicable local codes. Proper grounding is required for safety. THIS PRODUCT MUST BE INSTALLED IN ACCORDANCE WITH THE APPLICABLE INSTALLATION CODE BY A PERSON FAMILIAR WITH THE CONSTRUCTION AND OPERATION OF THE PRODUCT AND THE HAZARDS INVOLVED.

**WARNING: Make certain power is OFF before installing or maintaining fixture. No user serviceable parts inside. Suitable for damp locations.**

### FOR V-HOOK / CHAIN MOUNTING

Mount **Housing** to sturdy ceiling structure as follows:

1. **V-Hook (2)** and **3.28ft Chain (2)** are provided for mounting. Secure **V-Hooks** through **Side Slots** on housing as shown in Fig. 1 and 2. Secure **Chain** to **V-Hooks** as shown in Fig. 2 and 3.
2. Remove **Access Plate** (See Fig. 2 for RBAY17S & RBAY17M, see Fig. 3 for RBAY17L) and feed supply wires with strain relief connector. Make electrical connections as shown in wiring diagram (Fig. 14). Use approved wiring connectors and wire to local NEC codes. Push all wires back into **Housing**. Be careful not to pinch wires.
3. Reinstall **Access Plate** and secure with supplied **Screw (1)**.

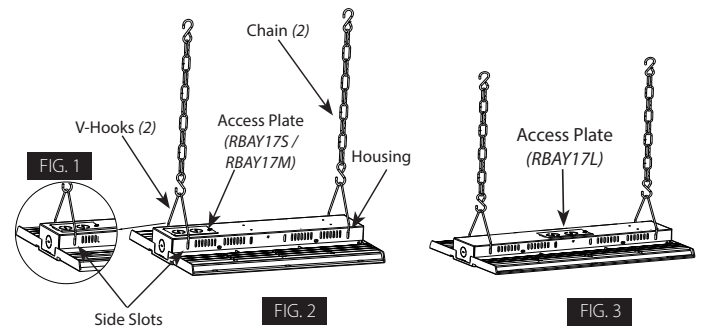

### RBAY17S / RBAY17M PENDANT MOUNTING

(Accessory ordered separately - Model# PMKRBAY17S and PMKRBAY17M)

1. Choose length of a **3/4" NPS Pendant Stem (by others)**.
2. Install **Pendant Junction Box (ordered separately)** to **Pendant Stem (by others)** and secure with **Locknuts (by others)** as shown in Fig. 5.
3. Mount **Housing** onto the **Pendant Junction Box** by securing with **Hook** feature and tightening (2) **Screws (provided)** as shown in Fig. 6.
4. Remove the **Knockout** from **Side Panel** (Fig. 6). Pull supply wires through side **Knockout** and feed supply wires through **Flex Conduit (provided)** as shown in Fig. 6. Secure **Flex Conduit** to **Side Panel** and secure **Side Panels** with (2) **Screws (provided)** as shown in Fig. 4. Wire the **Housing** leads to supply wires using UL listed wire connectors according to NEC and local codes.
5. Push all wires back into **Housing**. Be careful not to pinch wires.
6. Secure **Flex Conduit** to **Access Plate** (Fig. 6).

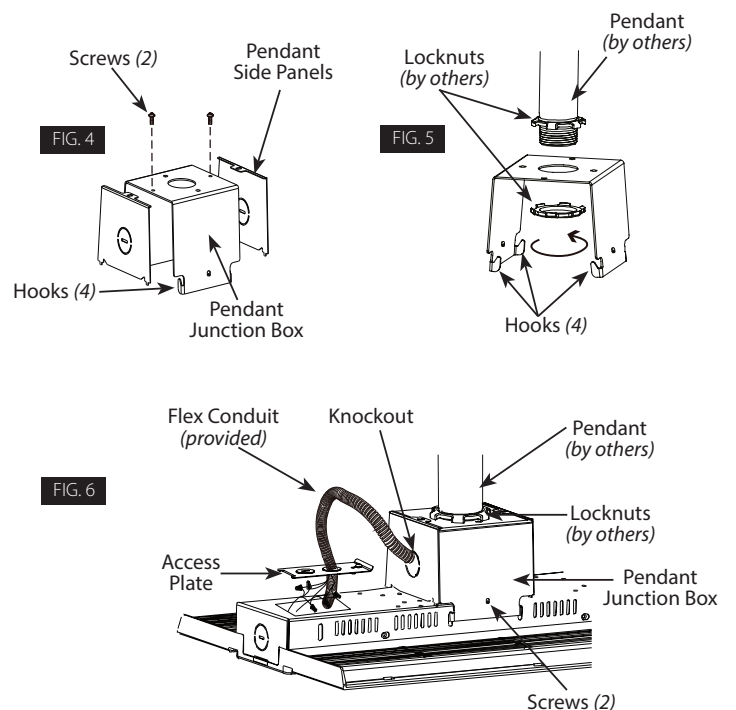

# INSTRUCTIONS

## FIELD-ADJUSTABLE RBAY17™ INSTALLATION



RAB Lighting is committed to creating high-quality, affordable, well-designed and energy-efficient LED lighting and controls that make it easy for electricians to install and end users to save energy. We'd love to hear your comments. Please call the Marketing Department at 888-RAB-1000 or email: [marketing@rablighting.com](mailto:marketing@rablighting.com)

### RBAY17L PENDANT MOUNTING

(Accessory ordered separately - Model# PMKRBAY17L)

1. Choose length of a 3/4" NPS **Pendant Stem** (by others).
2. Install **Pendant Junction Box** (ordered separately) to **Pendant Stem** (by others) and secure with **Locknuts** (by others) as shown in Fig. 5.
3. Pull supply wires and connect to **Housing** leads using UL listed wire connectors according to NEC and local codes.
4. Push all wires back into **Housing** and secure **Access Plate** with provided **Screw** (1).
5. Mount **Housing** onto the **Pendant Junction Box** by securing into the **Hook** feature and tightening (2) **Screws** (provided) as shown in Fig. 8
6. Install **Side Panels** with provided (2) **Screws** (provided) (Fig. 8). Be careful not to pinch wires.

FIG. 7

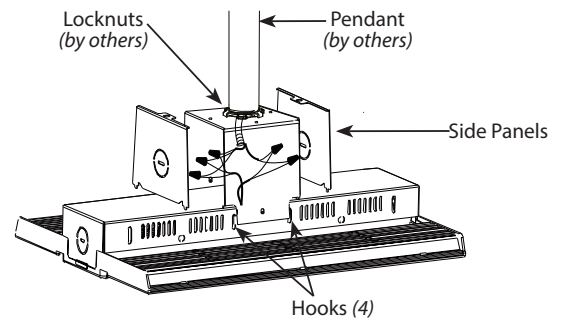
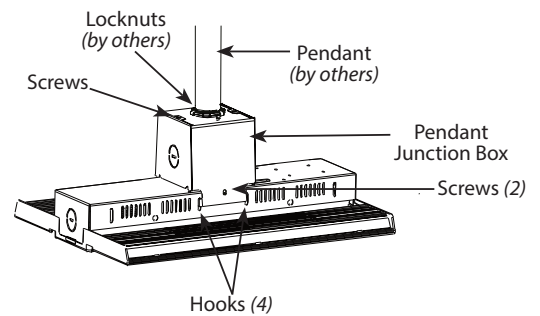

FIG. 8



### RBAY17S / RBAY17M SURFACE MOUNTING

Mount **Surface Mounting Bracket** to sturdy structure as follows:  
(Accessory ordered separately - Model# SMKRBAY17S and SMKRBAY17)

1. Install **Surface Mounting Bracket** (ordered separately) to sturdy surface with **Fastener** (by others) as shown in Fig. 9.
2. Wire the **Housing** leads to supply wires using UL listed wire connectors according to NEC and local codes. Secure **Access Plate** with (1) **Screw** (provided).
3. Mount **Housing** onto the **Surface Mounting Bracket** by securing with **Hook** (4) feature and (2) **Screws** (provided) as shown in Fig. 10.

FIG. 9

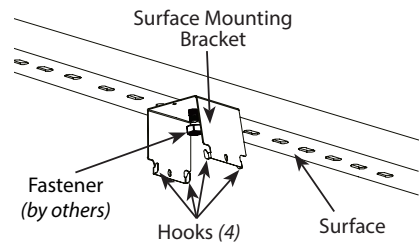

FIG. 10

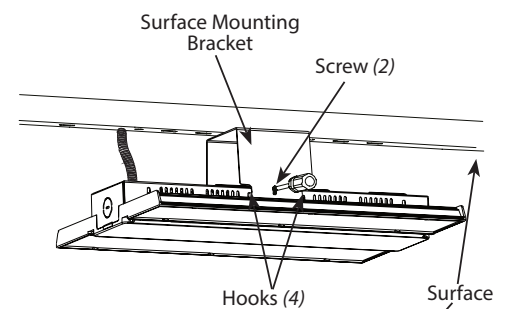
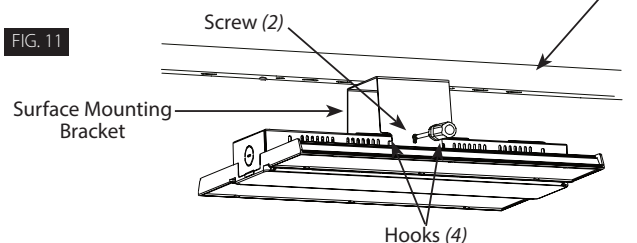

FIG. 11



### RBAY17L SURFACE MOUNTING

Mount **Surface Mounting Bracket** to sturdy surface as follows:  
(Accessory ordered separately - Model# SMKRBAY17)

1. Install **Surface Mounting Bracket** (ordered separately) to sturdy surface with **Screws** (by others) as shown in Fig. 9.
2. Wire the **Housing** leads to supply wires using UL listed wire connectors according to NEC and local codes. Secure **Access Plate** with (1) **Screw** (provided).
3. Mount **Housing** onto the **Surface Mounting Bracket** by securing with **Hook** (4) feature and (2) **Screws** (provided) as shown in Fig. 11.

# INSTRUCTIONS

## FIELD-ADJUSTABLE RBAY17™ INSTALLATION



RAB Lighting is committed to creating high-quality, affordable, well-designed and energy-efficient LED lighting and controls that make it easy for electricians to install and end users to save energy. We'd love to hear your comments. Please call the Marketing Department at 888-RAB-1000 or email: [marketing@rablighting.com](mailto:marketing@rablighting.com)

### FIELD ADJUSTMENT

Follow instructions below to change the **Fixture Power (W)** and/or **Color Temperature (CCT)** from factory settings:

#### Factory Settings:

RBAY17S	130/100/80W	130W / 4000K
RBAY17M	260/220/160W	260W / 4000K
RBAY17L	400/320/260W	400W / 4000K

1. Locate the selector switches located on the side of the housing as shown (RBAY17S, RBAY17M Fig. 12, RBAY17L Fig. 13).
2. Select **Color Temperature (CCT)** and/or **Power (W)** by sliding the respective switch to the desired value.

FIG. 12

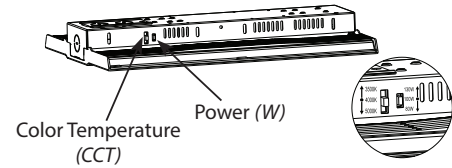
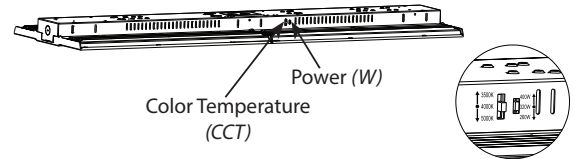

FIG. 13



### MVS/PIR SENSOR INSTALLATION

For units ordered with **MVS** or **PIR Sensor** follow directions below.

1. Remove **Sensor Base Plug** located on the **Housing** as shown in Fig. 14.
2. Insert **MVS** or **PIR Sensor** into the **Sensor Base Plug** and turn to secure as shown in Fig. 15.
3. See **MVS/PIR Sensor** instructions for pre-sets and programmable settings.
4. Use optional remote Model# MSR1 (ordered separately) for user programming.

FIG. 14

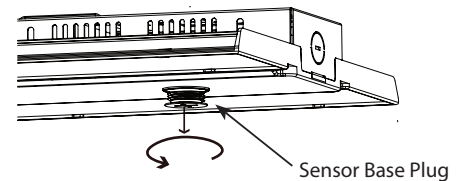
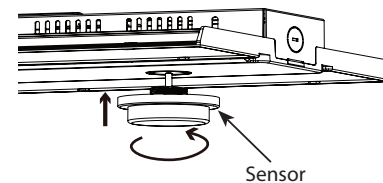

FIG. 15



### 0-10V DIMMABLE WIRING

Universal voltage driver permits operation at 120V through 277V, 50 or 60 Hz. Units ordered with /480 suffix are 480V, 50 or 60Hz only. For 0-10V dimming, follow the wiring directions as shown in Fig. 16.

1. Connect the black fixture lead to the **LINE** supply lead.
2. Connect the white fixture lead to the **COMMON** supply lead.
3. Connect the **GROUND** wire from fixture to supply ground.
4. Connect the purple fixture lead to the (V+) DIM lead.
5. Connect the pink fixture lead to the (V-) DIM lead.

**NOTE:** Do not connect DIM V+ (purple)/ DIM V- (pink) to line voltage or supply ground.

FIG. 16

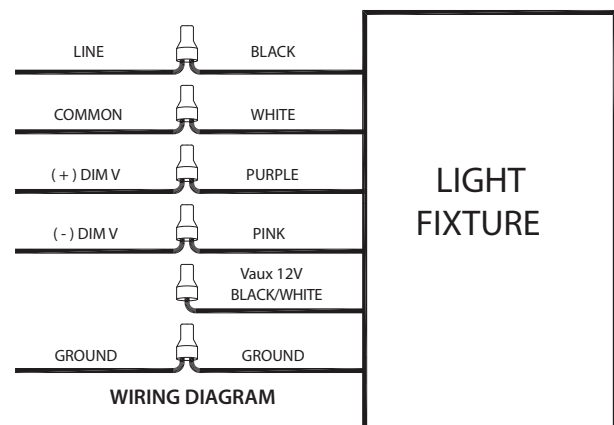

# INSTRUCTIONS

## FIELD-ADJUSTABLE RBAY17™ INSTALLATION



RAB Lighting is committed to creating high-quality, affordable, well-designed and energy-efficient LED lighting and controls that make it easy for electricians to install and end users to save energy. We'd love to hear your comments. Please call the Marketing Department at 888-RAB-1000 or email: [marketing@rablighting.com](mailto:marketing@rablighting.com)

### CLEANING & MAINTENANCE

---

**CAUTION: Be sure fixture temperature is cool enough to touch. Do not clean or maintain while fixture is energized.**

1. Lens can be washed only after removing from fixture and only in a solution of warm water and any mild, non-abrasive household detergent, rinsed with clean water and wiped dry. Do not use chemicals to clean Lens or fixture.
2. Do not open fixture to clean the LED. Do not touch the LED.

*Note: These instructions do not cover all details or variations in equipment nor do they provide every possible situation during installation, operation or maintenance.*

### TROUBLESHOOTING

---

1. Check that the line voltage at the fixture is correct.
2. Be sure the fixture is grounded properly.

*Note: These instructions do not cover all details or variations in equipment nor do they provide for every possible situation during installation, operation or maintenance.*

# INSTRUCTIONS

## FIELD-ADJUSTABLE RBAY17™ INSTALLATION



RAB Lighting is committed to creating high-quality, affordable, well-designed and energy-efficient LED lighting and controls that make it easy for electricians to install and end users to save energy. We'd love to hear your comments. Please call the Marketing Department at 888-RAB-1000 or email: [marketing@rablighting.com](mailto:marketing@rablighting.com)

# BATTERY BACKUP MODELS

## WIRING

**CAUTION: FOR BATTERY BACKUP FIXTURE.** Voltage can be present in **BATTERY**. To prevent high voltage from being present on output leads, Inverter connector must be open. Do not join **BATTERY** connector until installation is complete and AC power is supplied to the emergency driver (Fig.17).

**NOTE:** Make sure that the necessary branch circuit wiring is available. An **UNSWITCHED AC** source of power is required. The emergency driver must be fed from the same branch circuit as the LED driver.

**CAUTION:** Do not use any supply voltage other than 120-277V 50/60 Hz.

1. Connect **UNSWITCHED HOT** fixture lead to **HOT AC** supply line.
2. If using an **UNSWITCHED** circuit, connect **UNSWITCHED** and **SWITCHED** lines together.
3. If using a **SWITCHED** circuit, connect **SWITCHED HOT** AC fixture lead to the external.
4. Connect the pink fixture lead to the (V-) **DIM** lead.
5. For 0-10V dimming, connect **DIM (+)** purple and **DIM (-)** pink leads to 0-10V dimming connection. Do not connect **GROUND** to the output leads.
6. All unused leads must be capped and insulated.
7. When power is on, the fixture should be on and the **CHARGING INDICATOR LIGHT** should illuminate to indicate the battery is charging.
8. Once the **BATTERY** has charged for at least one hour, a short duration test may be performed by pressing the **Test Button** as shown in Fig. 18.
9. After the battery has charged for 24 hours, a long duration test can be performed by disconnecting power to the fixture.

## OPERATION

1. When AC power is applied the charging indicator light is illuminated indicating that the **BATTERY** is being charged.
2. When power fails the standby power automatically switches to emergency power (*internal battery*) operating at reduced illumination.
3. When AC power is restored the emergency driver automatically returns to charging mode.

## MAINTENANCE

Although no routine maintenance is required to keep the emergency driver functional, it should be checked periodically to ensure that it is working. The following schedule is recommended:

1. Visually inspect the charging indicator light monthly. It should be illuminated
2. Test the emergency operation of the fixture at 30-day intervals for a minimum of 30 seconds.
3. Conduct a 90-minute discharge test once a year. Fixture would operate at reduced illumination for a minimum of 90 minutes.

## TROUBLESHOOTING

1. Be sure the fixture is grounded properly.
2. If the charging indicator light does not illuminate after pressing the **Test Button** (Fig. 18), check if battery is connected properly.

FIG. 17

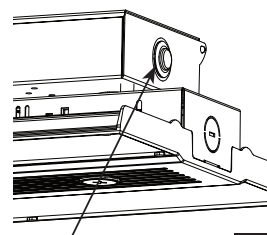
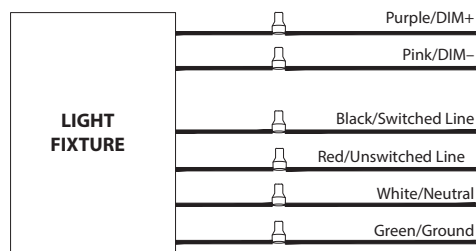

RBAY17S Test Button

FIG. 18

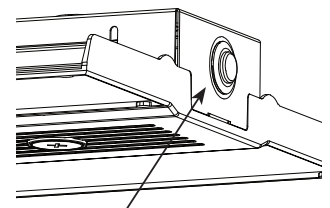

RBAY17M / RBAY17L Test Button

**Note:** These instructions do not cover all details or variations in equipment nor do they provide for every possible situation during installation, operation or maintenance.



© 2022 RAB LIGHTING Inc.

RBAY17 S-M-L - IN - 1022  
P-100141

### Easy Answers

[rablighting.com](http://rablighting.com)  
Visit our website for product info

**Tech Help Line**  
Call our experts: 888 722-1000

**e-mail**  
Answered promptly - [sales@rablighting.com](mailto:sales@rablighting.com)

**Free Lighting Layouts**  
Answered online or by request

**RAB WARRANTY:** RAB's warranty is subject to all terms and conditions found at [rablighting.com/warranty](http://rablighting.com/warranty).