

# INSTRUCTIONS

## CRXLED Field-Adjustable Downlight Installation

# RAB®

RAB Lighting is committed to creating high-quality, affordable, well-designed and energy-efficient LED lighting and controls that make it easy for electricians to install and end users to save energy. We'd love to hear your comments. Please call the Marketing Department at 888-RAB-1000 or email: [marketing@rablighting.com](mailto:marketing@rablighting.com)

CRX3  
CRX4  
CRX6  
CRX6/D10  
CRX8/D10



### IMPORTANT

#### READ CAREFULLY BEFORE INSTALLING FIXTURE. RETAIN THESE INSTRUCTIONS FOR FUTURE REFERENCE.

RAB fixtures must be wired in accordance with the National Electrical Code and all applicable local codes. Proper grounding is required for safety. THIS PRODUCT MUST BE INSTALLED IN ACCORDANCE WITH THE APPLICABLE INSTALLATION CODE BY A PERSON FAMILIAR WITH THE CONSTRUCTION AND OPERATION OF THE PRODUCT AND THE HAZARDS INVOLVED.

#### WARNINGS:

- Risk of electrical shock. Disconnect power at fuse or circuit breaker before installing or servicing.
- To prevent early lamp failure, lamp should only be installed in operating environments ranging between -20°C and 40°C (-4°F and 104°F).
- No user serviceable parts inside. To avoid electrical shock do not disassemble product.
- LED Retrofit Kit installation requires knowledge of luminaires electrical systems. If not qualified, do not attempt installation. Contact a qualified electrician.
- Install this kit only in luminaires that have the construction features and minimum dimensions shown in these instructions and where the input rating of the retrofit kit does not exceed the input rating of the luminaire.
- Do not make or alter any open holes in an enclosure of wiring or electrical components during kit installation
- To prevent wiring damage or abrasion, do not expose wiring to edges of sheet metal or other sharp objects.
- The retrofit kit is accepted as a component of a luminaire where the suitability of the combination shall be determined by authorities having jurisdiction. Product must be installed by a qualified electrician in accordance with the applicable and appropriate electrical codes. The installation guide does not supersede local or national regulations for electrical installations.
- Minimum 90°C supply conductors
- Installers should examine all parts that are not intended to be replaced by the retrofit kit for damage and replace any damaged parts prior to installation of the retrofit kit.

This equipment has been tested and found to comply with the limits for a Class A digital device, pursuant to part 15 of the FCC Rules. These limits are designed to provide reasonable protection against harmful interference when the equipment is operated in a commercial environment. This equipment generates, uses, and can radiate radio frequency energy and, if not installed and used in accordance with the instruction manual, may cause harmful interference to radio communications. Operation of this equipment in a residential area is likely to cause harmful interference in which case the user will be required to correct the interference at his own expense.

### WHAT'S IN THE BOX

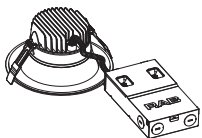

Downlight (1)



Lumi Sticker (1)



Template (1)

Shall be marked on the retrofit luminaire where readily visible by the user during normal maintenance including relamping.

### TOOLS NEEDED

This downlight requires very few tools for installation. A screwdriver and a pair of wirecutters will help to install the downlight to a junction box or housing.

# INSTRUCTIONS

## CRXLED Field-Adjustable Downlight Installation



RAB Lighting is committed to creating high-quality, affordable, well-designed and energy-efficient LED lighting and controls that make it easy for electricians to install and end users to save energy. We'd love to hear your comments. Please call the Marketing Department at 888-RAB-1000 or email: [marketing@rablighting.com](mailto:marketing@rablighting.com)

### INSTALLATION INSTRUCTIONS

1. Turn power OFF from the electrical panel before installation.
2. Use template inside box to cut hole in ceiling. (Fig.1)

Fig: 1

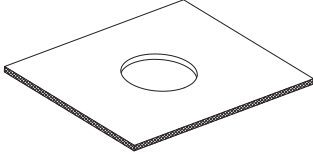

3. Open the driver box and remove the knockout(s). (Fig.2)

Fig: 2

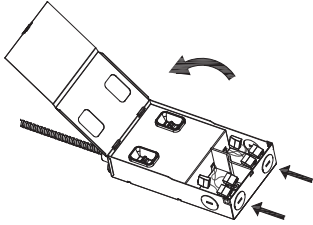

4. Insert the electrical supply cable through the knockout and secure with a nut. Wire driver box (Fig.3) , white-white, black - black, green - green/ground, purple-purple, pink-pink, yellow-yellow.

Fig: 3

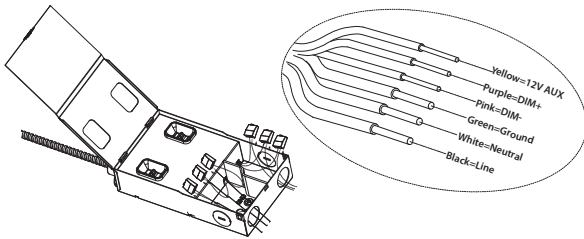

5. Place all wiring and connections back into the box, close the cover and select desired CCT and wattage. (Fig.4)

Fig: 4

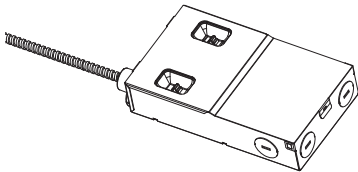

### INSTALLATION INSTRUCTIONS (cont'd)

6. Place the driver box into the ceiling and connect the fixture to driver box. (Fig.5)

Fig: 5

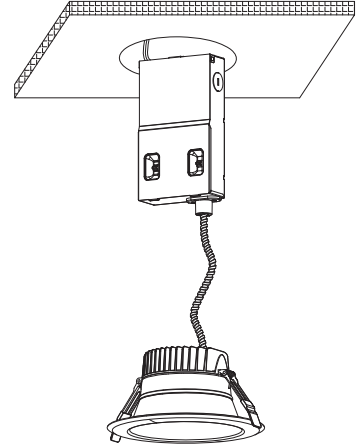

7. Lifting both retention tabs upward, push until the trim sits flush against the ceiling (Fig. 6)

Fig: 6

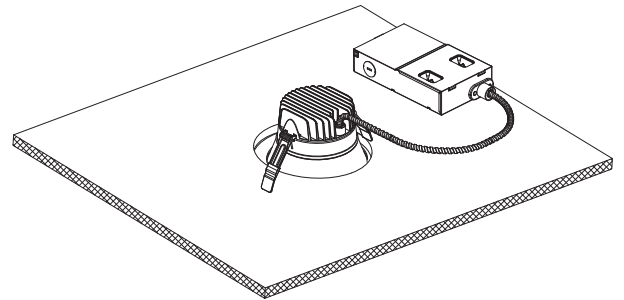

# INSTRUCTIONS

## CRXLED Field-Adjustable Downlight Installation

# RAB®

RAB Lighting is committed to creating high-quality, affordable, well-designed and energy-efficient LED lighting and controls that make it easy for electricians to install and end users to save energy. We'd love to hear your comments. Please call the Marketing Department at 888-RAB-1000 or email: [marketing@rablighting.com](mailto:marketing@rablighting.com)

### INSTALLATION WITH PLATE

---

1. Turn power OFF from the electrical panel before installation.
2. Cut out the aperture required for fixture installation on the mounting plate. (Fig.1)

Fig: 1

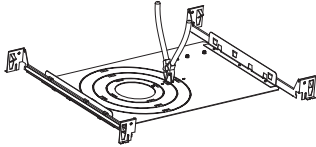

3. Select desired CCT and wattage. (Fig.2)

Fig: 2

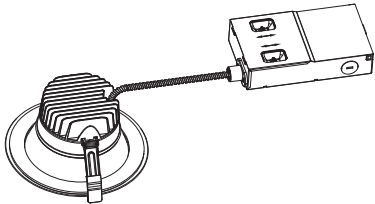

4. Pass the junction box through the mounting hole and insert the fixture into the mounting plate. (Fig.3)

Fig: 3

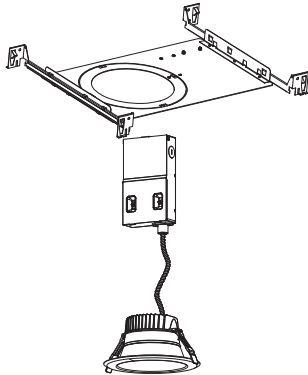

5. Fasten the junction box to the mounting plate with screws. (Fig.4)

Fig: 4

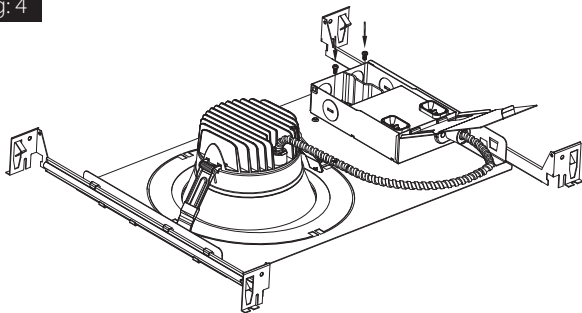

**Note:** These instructions do not cover all details or variations in equipment nor do they provide for every possible situation during installation, operation or maintenance.

# INSTRUCTIONS

## CRXLED Field-Adjustable Downlight Installation



RAB Lighting is committed to creating high-quality, affordable, well-designed and energy-efficient LED lighting and controls that make it easy for electricians to install and end users to save energy. We'd love to hear your comments. Please call the Marketing Department at 888-RAB-1000 or email: [marketing@rablighting.com](mailto:marketing@rablighting.com)

### MINIMUM CEILING PLENUM DIMENSION

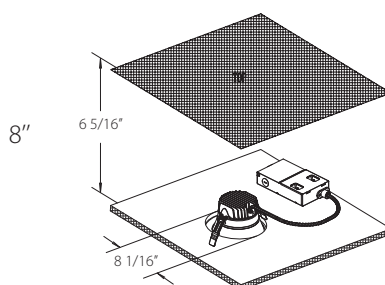
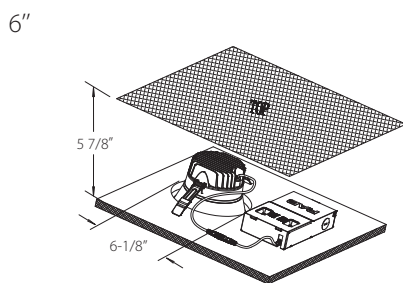
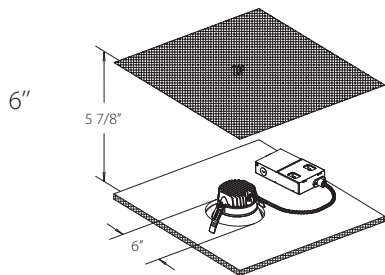
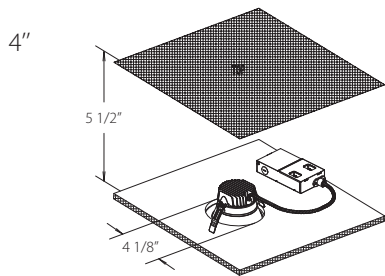
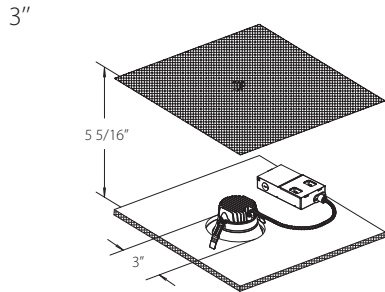

### DIMENSIONAL DRAWINGS

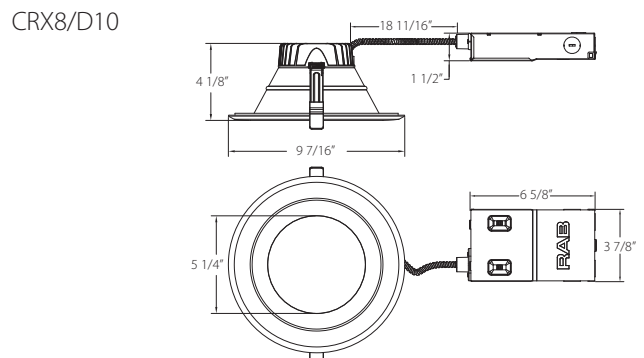
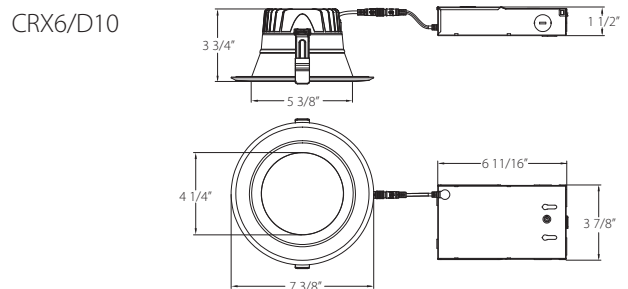
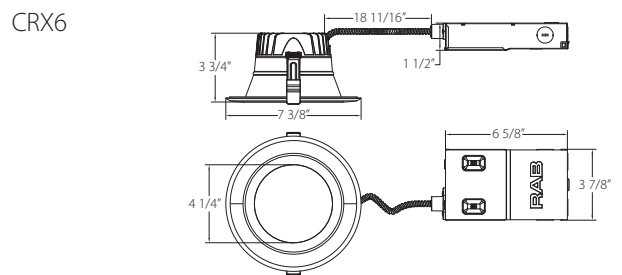
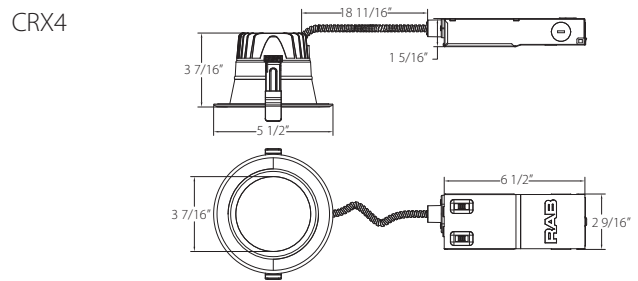
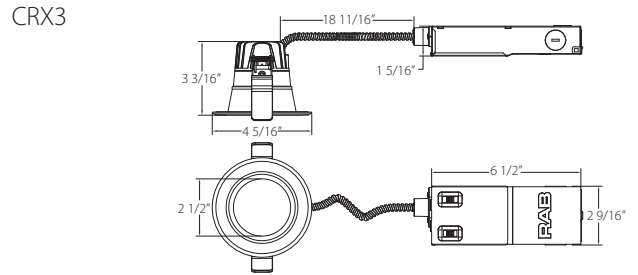

# INSTRUCTIONS

## CRXLED Field-Adjustable Downlight Installation



RAB Lighting is committed to creating high-quality, affordable, well-designed and energy-efficient LED lighting and controls that make it easy for electricians to install and end users to save energy. We'd love to hear your comments. Please call the Marketing Department at 888-RAB-1000 or email: [marketing@rablighting.com](mailto:marketing@rablighting.com)

### OPTIONAL ACCESSORIES

#### GOOF RING

Visit [rablighting.com](http://rablighting.com) for the downlight accessory compatibility lists.

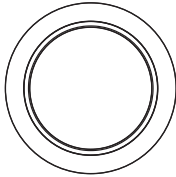

DL4-6GOOF/R/P/CRLEDFA  
For use with 6" ceiling hole applications

DL6-8GOOF/R/P/CRLEDFA  
For use with 8" ceiling hole applications

DL8-10GOOF/R/P/CRLEDFA  
For use with 10" ceiling hole applications

#### PLATE

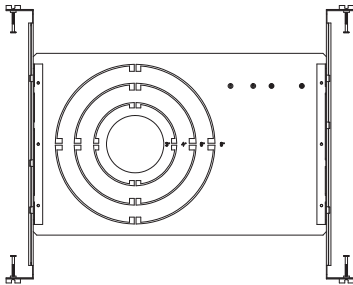

DLPLATE/WFR3468/NB  
Mounting plate with nailer bar

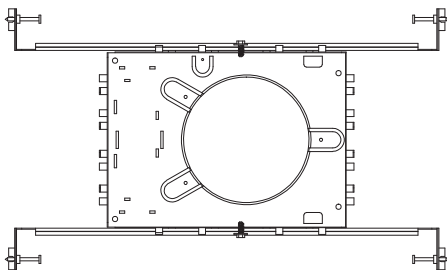

DLPLATE/WFR4/NB/CL  
Only compatible with CRX4

### OPTIONAL ACCESSORIES (cont'd)

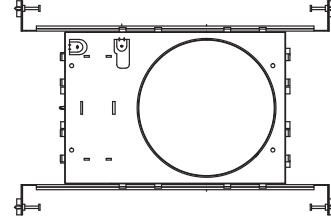

DLPLATE/WFR6/NB/CL

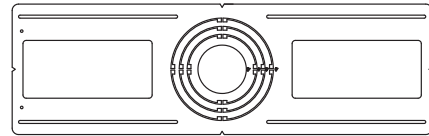

DLPLATE/WFR3456  
Only compatible with CRX4 and CRX6

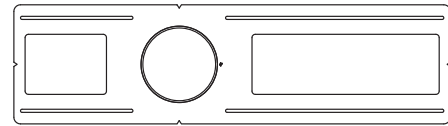

DLPLATE/WFR4  
Only compatible with CRX4

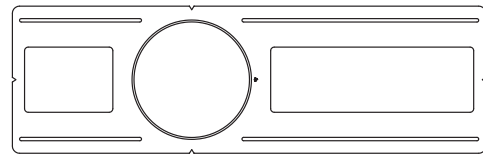

DLPLATE/WFR6  
Only compatible with CRX6

#### Easy Answers

[rablighting.com](http://rablighting.com)  
Visit our website for product info

Tech Help Line  
Call our experts: 888 722-1000

e-mail  
Answered promptly - [sales@rablighting.com](mailto:sales@rablighting.com)

Free Lighting Layouts  
Answered online or by request